

Developing Efficient Numeracy Strategies

Stage 2

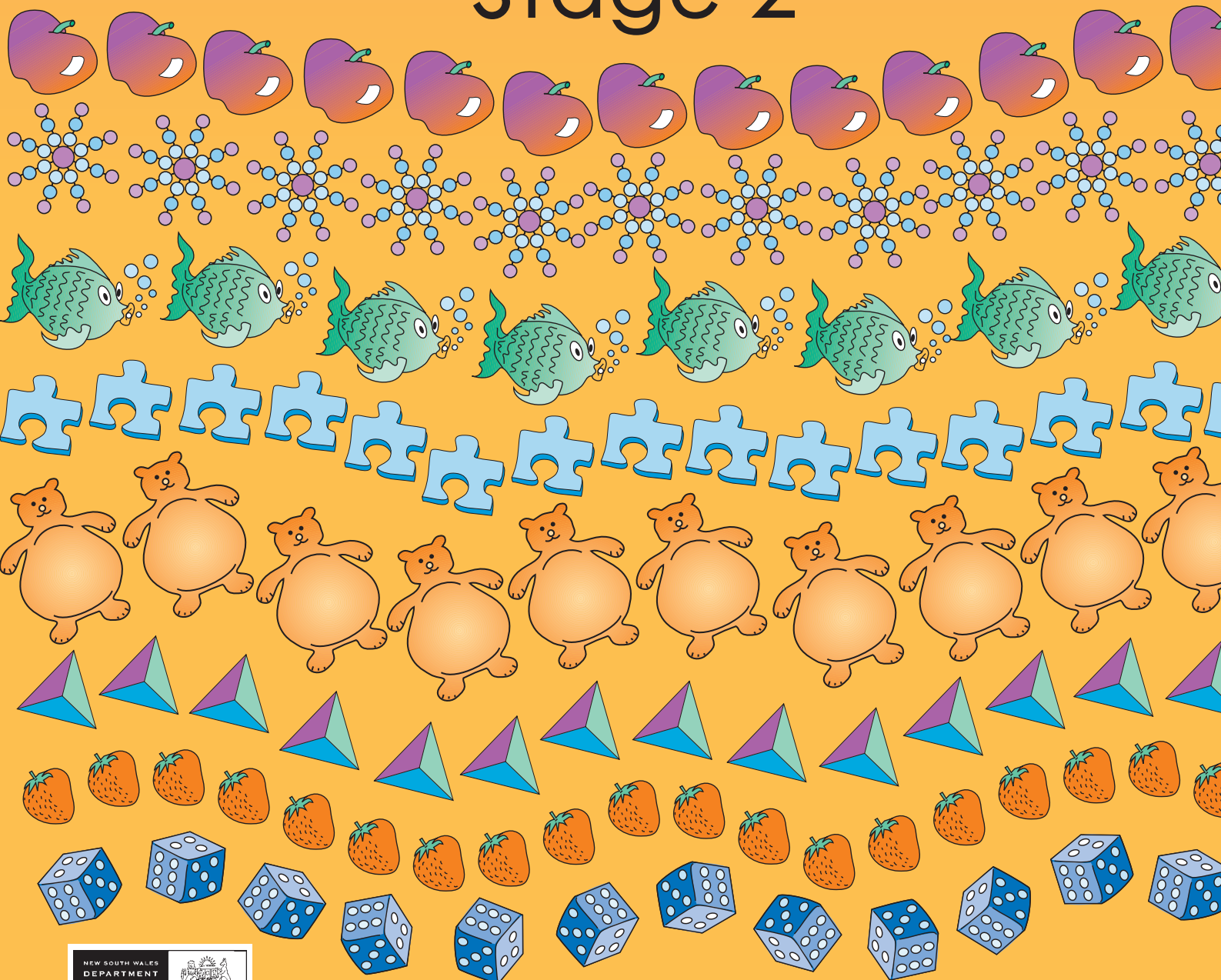



STAGE 2

Developing efficient numeracy strategies



Acknowledgement

Board of Studies, NSW: for permission to include the outcomes from the *Mathematics K–6 syllabus*, 2002, Board of Studies, NSW.

Developing efficient numeracy strategies: Stage 2

© State of NSW
2003, Department of Education and Training
Professional Support and Curriculum Directorate

Design and layout

Aston Hunt Design Services

Restricted waiver of copyright

This work is subject to a restricted waiver of copyright to allow copies to be made within DET workplaces, subject to the following conditions:

1. All copies shall be made without alteration or abridgement and must retain acknowledgement of the copyright.
2. The work must not be copied for the purposes of sale or hire or otherwise be used to derive revenue.
3. The restricted waiver of copyright is not transferable and may be withdrawn if any of these conditions are breached.

ISBN 0 7313 8215 3

SCIS 1119093

Additional copies are available for sale from:

DET Sales
PO Box 22
BANKSTOWN NSW 2200
Telephone: (02) 9793 3086
Facsimile: (02) 9793 3242

Foreword

Supporting the effective learning of mathematics relies on understanding what students know and need to learn, and providing opportunities for all students to learn with understanding. Learning mathematics with understanding is essential to enable students to solve the new kinds of problems they will inevitably face in the future. Students' understanding of mathematical ideas can be built throughout their school years if they actively engage in tasks and experiences designed to deepen and connect their knowledge.

One of the central understandings that students develop in Stage 2 is the coordination of multi-units or groups of groups. Students' understanding of the base-ten number system is deepened as they come to understand its multiplicative structure. That is, 253 is seen as 2×100 plus 5×10 plus 3×1 as well as a collection of 253 individual objects. This type of multiplicative reasoning is further developed as students use a rectangular array as a geometric model of multiplication, and adapt this model to work out the area of shapes and the volume of solids.

Developing efficient numeracy strategies: Stage 2 also focuses on the role played by recordings in sharing thinking. Finding multiple ways to represent ideas lies at the heart of mathematics. We need to help students to learn how to talk about mathematics, to explain their answers, and to describe their strategies.

We work in exciting times in education. Never before has there been such widespread adoption of the findings of educational research operating in mathematics classrooms. I commend *Developing efficient numeracy strategies: Stage 2* as a resource to aid in the implementation of the new *Mathematics K–6* syllabus and to assist in strengthening the communities of mathematics learners in our schools.



Robert Randall
Director
Professional Support and Curriculum Directorate

About this book

Developing efficient numeracy strategies: Stage 2 is organised into three main sections based on increasingly efficient counting and grouping strategies. The three sections are: Counting by ones, Forming groups and Coordinating groups.

- **Counting by ones**

The activities within this section are intended to develop strategies students use beyond counting-based strategies. Within the *Count Me In Too* project's learning framework, these students would typically be identified as being at the *Counting on and back stage* of early arithmetical strategies.

- **Forming groups**

The activities within this section are intended for students who no longer rely on counting-by-ones strategies and are able to apply a range of grouping strategies to solve problems. Within the *Count Me In Too* project's learning framework, these students would typically be identified as being at the *Facile stage* of early arithmetical strategies.

- **Coordinating groups**

The idea of coordinating groups is fundamental to multiplication and division, place value, measurement and spatial concepts. The activities within this section are intended to develop students' use of collection-based strategies to solve problems through a focus on mental computation.

Assessing your students' strategies

An overview of the key strategies students use at each of these developmental stages is provided at the start of each section.

You will need to ascertain your students' current problem-solving strategies and counting skills in order to choose the most appropriate teaching activities.

Managing parts and wholes

Recognising and manipulating *parts* and *wholes* is basic to all mathematics development. Individual numbers, such as one, two and three, become parts of other numbers ($2 + 3 = 5$), individual shapes become parts of other shapes and parts of shapes such as angles become things of interest by themselves.

Students learn to do arithmetic by becoming adept at counting and developing methods to keep track of completed counts of multiples. As students learn to tie together number names and completed counts, they also learn to combine these *number facts*. As their skills grow, they tend to rely less and less on counting. Combining and partitioning become the basis of arithmetical operations.

Just as *counting* describes more than generating a sequence of words, *grouping* captures a range of procedures. Grouping procedures include the formation of groups as units, instant recognition of units, combining and separating groups within a unit and coordinating groups of groups. Managing parts and wholes in grouping aids the development of place value understanding.

Understanding the relationships between parts and wholes is important in all strands of mathematics. Within the Space strand, the focus and nature of students spatial understanding develops from shifting attention from the whole or global features of shapes and objects such as triangles or boxes, to the parts. The relationship between the parts and the wholes results in the recognition of the properties of shapes and solids.

In the Measurement strand, measuring deals with identifying a unit that can be used, without gaps or overlaps, to break the whole into identical parts. Length, area and volume require repeated applications of a standard unit to create the whole. The number of units used provides a way of quantifying space.

The notion of “units within units” is important for separating and combining numbers as well as for multiplication, division, fractions and measurement.

The focus of this book is supporting the development of students’ strategies in counting and grouping of parts and wholes.

Place value

Interpreting number in terms of part–whole relationships makes it possible for students to think about a number as being made up of other numbers. This involves recognising that a number such as 19 can be partitioned into smaller groups of 10 and 9, as well as 11 and 8, 12 and 7 and so on. Breaking the whole into a range of parts can contribute to a richer understanding of place value that is needed to underpin the four operations with numbers.

As students work with larger numbers, grouping and re-grouping draws on the role played by *tens* in our number system. Grouping within place value involves the student understanding ten as a composite unit. That is, ten is composed of ten ones at the same time as being one unit called ten. The composite nature of ten allows it to be collected as multiples of ten as well as being re-formed by trading ten ones.

The mental methods that we use to answer questions such as 3×299 or $25 + 79$ draw on a rich understanding of tens in numbers. For the second example, this knowledge of tens and hundreds leads us to recognise that 80 is 1 more than 79 or $25 + 75 = 100$. This understanding of the flexible ways of using tens, hundreds and units with mental computation forms an essential foundation for formal algorithms.

Using recordings to share thinking

Students' explanations of their methods of working with numbers can also provide evidence of the increasing sophistication of strategies they use. Even asking students to explain how they think about finding the answer to a number combination such as $6 + 7$, can provide a wealth of information. The diverse methods of constructing an answer to this question can make use of recordings as a way of sharing thinking. The use of the *empty number line* as a method of recording thinking enables recordings to support the sharing of thinking. It also aids in building a mental model to assist thinking.

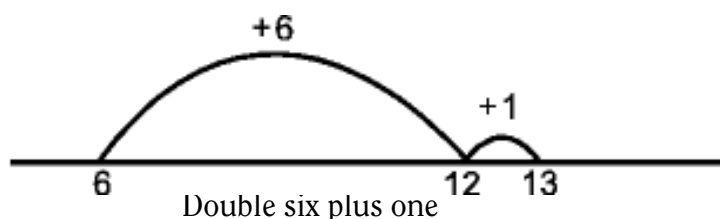

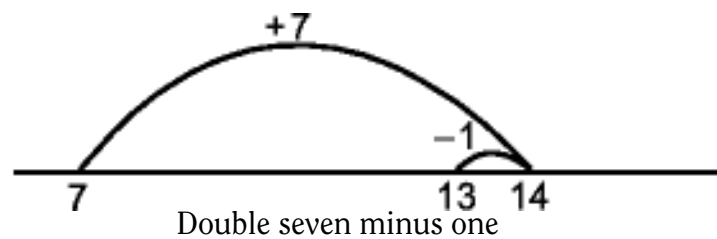
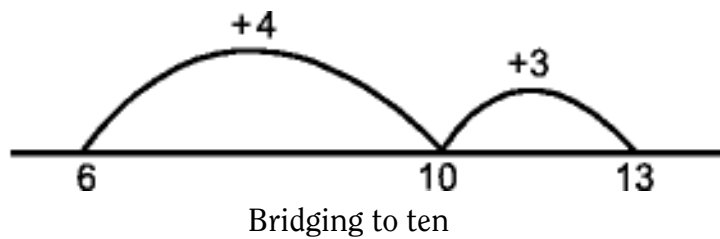

Purpose and direction

This book contains activities designed to build upon the students' current understandings and problem-solving strategies across the strands of *Number, Patterns and algebra, Data, Measurement and Space and geometry*.

The organisation of the material in this book emphasises both direction and purpose in the teaching of mathematics. It is based on the understanding that assessment of students' current knowledge is essential in planning appropriate teaching programs. This is sometimes referred to as assessment *for* learning.

The sections are sequenced to reflect development from counting by ones strategies, to grouping strategies, to the ability to coordinate groups of groups. Within each section the activities have been arranged to answer the fundamental questions of teaching mathematics:

What do my students currently know?

What do I want them to know?

How will I help them to know this?

How will I know when they know this?

How to use this book

The double-page layout of *Developing efficient numeracy strategies: Stage 2* organises four important aspects for planning effective teaching programs:

- identifying the students' current knowledge
- recognising the next step in the student's learning
- organising learning content to facilitate student progress
- identifying the purpose of the learning content and how it relates to the learning process.

These four aspects are addressed under the headings:

Where are they now?

(Identifying the students' current knowledge)

This component describes the types of approaches that students may use in attempting to solve problems.

Where to next?

(Recognising the next step in the students' learning)

This component provides direction for teachers in determining where students are heading in their learning.

How?

(Organising learning content)

This component outlines activities designed to assist students' mathematics development. The activities are suggested models for developing students' understanding and should be modified to suit the individual needs of the students and the available resources.

Why?

(Identifying the purpose of learning)

This component outlines the purpose of the activities.

Syllabus outcomes

Links have been identified between the activities and the 2002 *Mathematics Years K–6* syllabus outcomes.

Count Me In Too

Links have been identified between the activities and the *Count Me In Too* learning frameworks.

Short, practical assessment ideas are included at the end of each section. These ideas for assessing your students' development will enable you to determine if your students have progressed to the next stage of learning.

BLM

Black line masters (BLM) have been provided for many of the activities and are located at the end of each section.

Where a BLM has been provided for an activity, the title of the BLM and page number are shown.

Assessment tasks

Quick, practical assessment tasks are included at the end of each section. These tasks provide insight into students problem-solving strategies and will enable you to determine if students have progressed to the next stage of development.

Maths bites

Short, whole-class activities requiring little or no equipment are presented. These can be used to consolidate and practise skills and concepts, or as warm-up introductory activities to a lesson or as transition activities between lessons.

Other key features include written recordings and teaching points. The following icons identify these features:



Written recordings

Teaching directions and models for students' recording are linked to activities.



Teaching points

Ideas to help you organise the activities and further detail for teaching strategies are provided.

Icons are also used throughout the book to indicate whether the activities are appropriate for individuals, partners, small groups or whole class.



Individuals



Partners



Small group



Whole class

The background of the page is a light purple color with a pattern of overlapping geometric shapes, primarily triangles and polygons, in a slightly darker shade of purple. These shapes are scattered across the page, with some containing small white numbers. The numbers are also scattered and appear to be from a standard set of digits (0-9). The overall effect is a textured, abstract pattern. On the right side of the page, there are two solid purple rectangular blocks, one at the top and one at the bottom, which frame the central white area containing the title.

Counting by ones



Students using counting by ones strategies...

can often develop effective methods of solving problems. They may even become quite quick at using a count-by-one process. We have seen many students use elaborate finger strategies to assist their counting by ones, in particular with multiplication and division tasks. It is easy to assume these students are progressing satisfactorily, especially as this method of counting can give a correct answer.

While counting-by-ones is a satisfactory strategy for adding small numbers, it becomes a laborious process, often prone to miscalculations, when solving more complex problems involving larger numbers. These students need to develop efficient grouping strategies for solving problems.

The transition from counting-based strategies to collection-based methods is an important development. We need to assist students in developing a range of solution strategies beyond counting-by-ones.

The strategies described below are characteristic of students who have moved beyond a dominant use of non-count-by-ones strategies. These methods are typical of the *facile* counting stage.

Compensation for addition and subtraction. Seven plus three is the same as eight plus two. Sixteen take away nine is the same as seventeen take away ten.

Commuting for addition. Two and nine is the same as nine and two.

Using addition for subtraction. Eight and four is twelve, so twelve take away four is eight.

Using doubles. Nine and nine is eighteen, so eight and nine is seventeen.

Using a known fact. Four and three is seven, so twenty-four and three is twenty-seven.

Partitioning using five as a base. Four and three is the same as four and one and two.

Partitioning using ten as a base. Seven and six is the same as seven and three and three.

Using the tens-structure. Fifteen take away four is eleven because fifteen take away ten is five and four is one less than five.

Understanding that numbers can be regrouped is essential if students are to move beyond the reliance on counting-by-ones. For example, when solving $64 - 18$ seeing the number eighteen as eighteen ones is more limiting than also seeing that it can be flexibly regrouped, say into fourteen and four.

Combining and partitioning refers to the joining and separating of groups. Experiences with combining and separating groups can lead to the learning of number facts in a meaningful way.

The idea of groups within numbers lends itself to emphasising part-whole relationships, that is the student sees both the parts and the whole. This idea is also fundamental to place value, multiplication and measurement.

Part-whole relationships are also important to spatial understanding. In “Space” mathematics, part-whole relationships refer to how a shape is part of a larger shape. Students need to develop both visual imagery and appropriate language to describe shapes and objects as they analyse and mentally manipulate the parts as well as the “whole”.

Index of activities

	Page
Activities which develop facile counting strategies	
Domino adding pairs	20
Domino friends	22
Spin, double and flip	24
Addition star	26
Brainy fish	28
Addition wheel pairs	30
Singles or doubles?	32
Even Stevens	34
Engineer's dice	36
Fancy dice	38
Counter play	40
Activities which develop subitising	
Copy that	42
Using random patterns	44
Matching ten-frames	46
Activities which develop combining and partitioning	
Bunches of five	48
"Make ten" grids	50
Memory of tens	52
Couple cups	54
Nine piles	56
Number chop	58
Number draughts	60
Activities which develop counting by 10s and 100s	
Count-off	62
Number line counting	64
Hands up	66
Sticks of ten	68
Activities which develop place value strategies	
Bean counter	70
Dizzy dots	72
Building numbers with ten-frames	74
Hundred chart windows	76

	Page
Money problems	78
Four turns to 100	80
Eggsactly	82
Cover-up strips	84
Tracks	86
Hundred chart jigsaw	88
Teeny tiny ten-frames	90
Activities which develop multiplication and division strategies	
Teddy tummies: multiplication	92
People markers	94
Counter grab	96
Create an array	98
Colour an array	100
Self-correcting arrays	102
Activities which develop graphing skills	
Traffic tally	104
High rollers 1	106
Four dice tally	108
Knotty problems	110
Hoops and hats	112
Activities which develop measurement concepts and skills	
Chain reaction	114
Streamer design	116
Tile roller	118
Using nets 1	120
Activities which develop space concepts	
Geoboard triangles 1	122
Create a triangle	124
Symmetry pattern	126
Walking the dog	128
Woolly designs	130
Recognising angles in shapes	132
Counting by ones blackline masters	134
Assessment tasks	166
Maths bites	
Using numeral cards 0–30	168

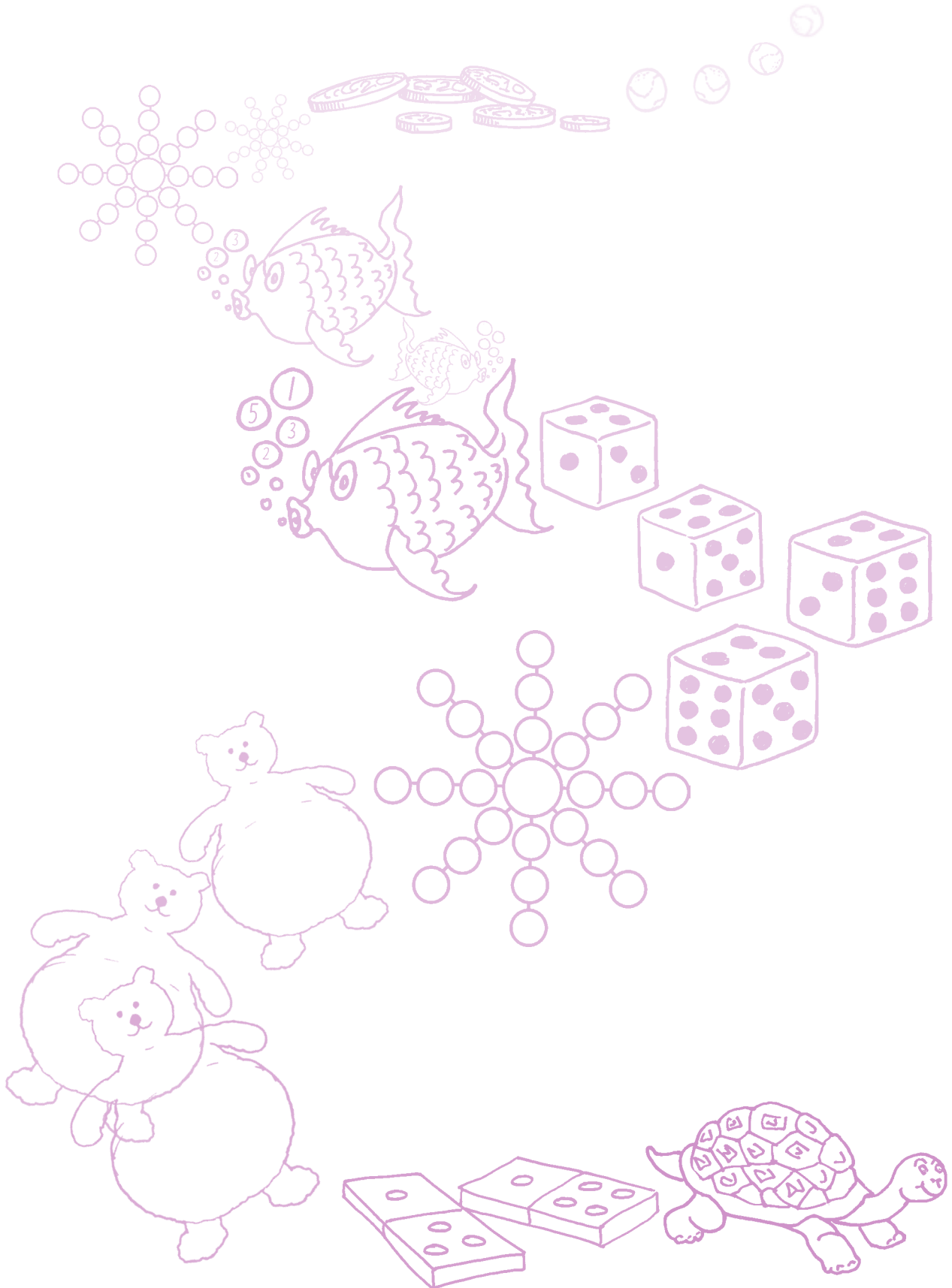

Domino adding pairs

Where are they now?

Students are able to add pairs of numbers to 20 by counting-on by ones.

Where to next?

Students use a range of non-count-by-one strategies including doubles, near-doubles and bridging to the next decade to solve addition problems.



Model making tens, using doubles or counting multiples to solve addition problems.

Syllabus outcomes

NS2.2: Uses mental and written strategies for addition and subtraction involving two- three- and four-digit numbers

WM2.3: Uses appropriate terminology to describe, and symbols to represent, mathematical ideas

CMIT reference

Building addition and subtraction through grouping: facile counting strategies

Combining and partitioning: level 1

Subitising: level 1, 2

BLM

Domino adding pairs, page 136

How?

Provide each pair of students with copies of *Domino adding pairs* BLM and a set of dominoes. Remove the “double blank” domino tile. Arrange the dominoes face down. Have the students take turns to select a pair of dominoes and place them onto the worksheet. The students initially record each dot pattern as a numeral and then determine and record the total for each domino. The students then calculate the total of the pair of dominoes. Ensure the students discuss how they are completing the sum and record the procedure they used on the worksheet.

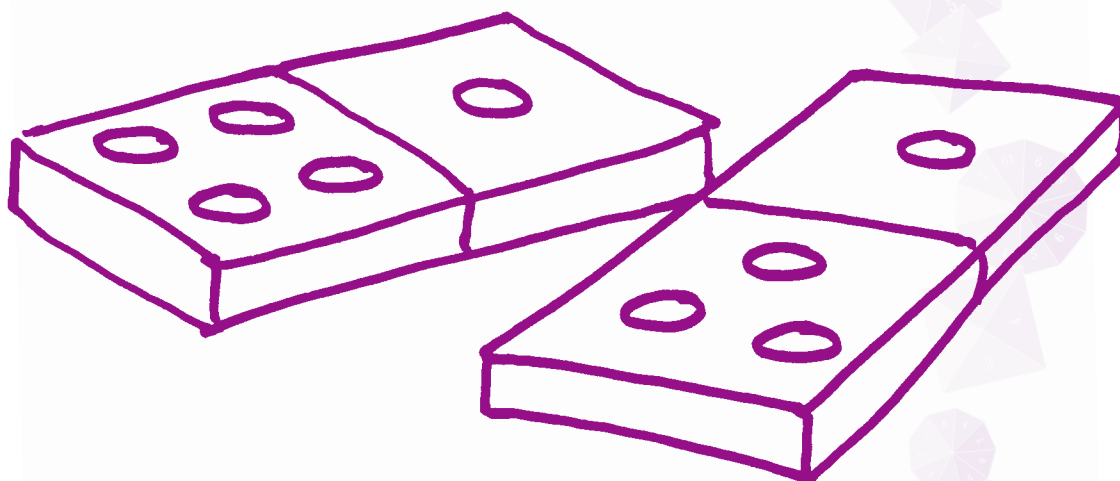

Why?

Students need to develop a variety of non-count-by-one strategies to assist them in solving addition and subtraction problems in an efficient way.

Domino friends

Where are they now?

Students use count-by-one strategies to solve addition problems.

Where to next?

Students use a range of non-count-by-one strategies including doubles, near-doubles and bridging to the next decade to solve addition problems.



Have the students model non-count-by-one strategies to solve addition problems prior to commencing the activity.

Syllabus outcomes

NS1.2: Uses a range of mental strategies and informal recording methods for addition and subtraction involving one- and two-digit numbers

WM2.3: Uses appropriate terminology to describe, and symbols to represent, mathematical ideas

NS2.5: Describes and compares chance events in social and experimental contexts

CMIT reference

Building addition and subtraction through grouping: facile counting strategies

How?

A large space is required for this activity. Organise the class so that each student draws a domino tile from a bag without the rest of the class seeing the tile. Once each student has a domino tile, instruct them to move around the room and call out the numbers represented by the dot pattern until they find a “friend” whose numbers total to the same as their own tile. The “friends” can then continue calling out their number to see if they are able to form a group with the same total. After the activity ask the students to look around to see which total had the best chance of finding a friend. Discuss with the class why some students could not find partners and why there were more of some numbers.

Variation

Have the students find friends that together have a total of say, 12 or more.

Why?

Students need to develop a variety of non-count-by-one strategies to assist them in solving addition and subtraction problems in an efficient way.

Spin, double and flip

Where are they now?

Students are able to solve addition and subtraction questions by counting by ones.

Where to next?

Students are able to use a variety of non-count-by-one strategies to solve addition problems.

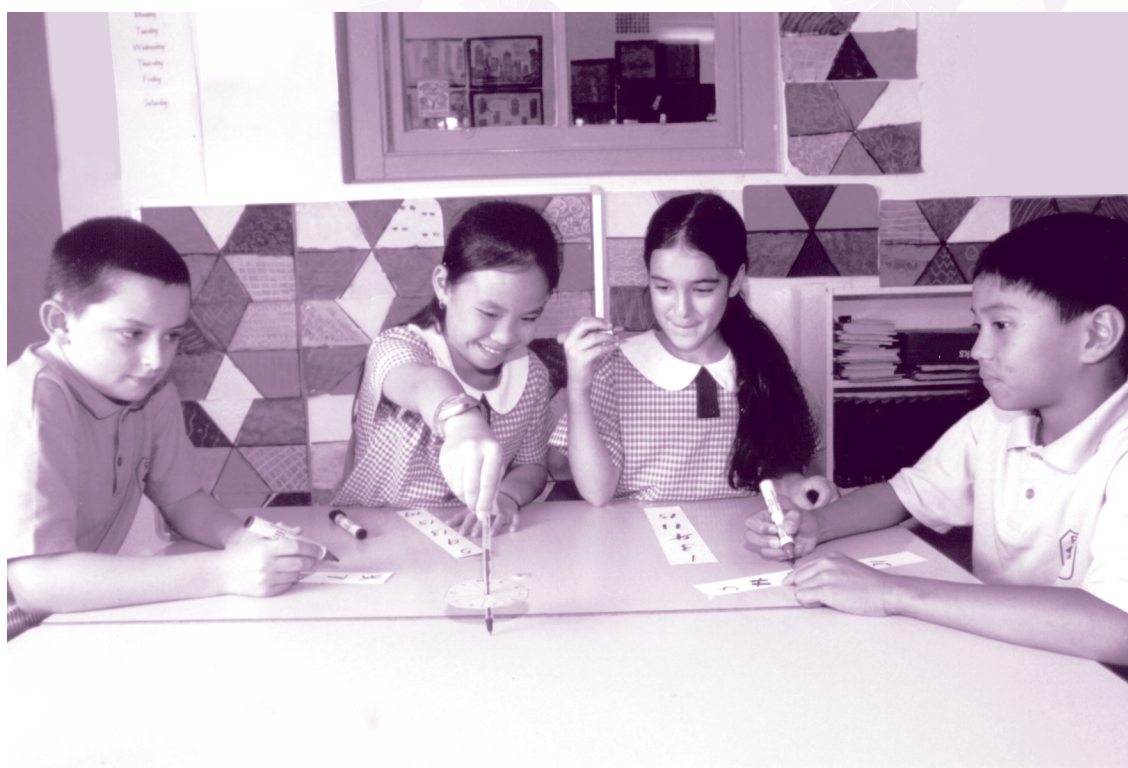

Syllabus outcomes

NS1.2: Uses a range of mental strategies and informal recording methods for addition and subtraction involving one- and two-digit numbers

WMS2.2: Selects and uses appropriate mental or written strategies, or technology, to solve problems

CMIT reference

Building addition and subtraction through grouping; facile counting strategies

How?

Prepare a spinner displaying numerals one to ten and a “flip counter”. To make the flip counter, on one side of a counter write “+1” and on the other side write “-1”.

Provide the students with a strip of paper on which to record five numbers in the range 1–21. Students take turns to spin a number on the spinner. They then double the number to find the answer. If the student has this number on their paper strip they may cross it off. If the doubled number is one more or one less than a number on their paper strip, the student may choose to toss the “flip counter”. The winner is the first person to cross off all five numbers.

Variations

All students in the group may cross off the answer if they have it on their paper strip.

Ask the students to write the five numerals vertically down a piece of paper. When the answer has been calculated the student records the number sentence next to the answer.

Students record three numbers on a paper strip instead of five.

Play as two teams before having the students play independently.

If a spinner is not available, use cards 1–10 or a ten-sided die.

Why?

Using knowledge of doubles and near doubles is an efficient strategy for solving some addition and subtraction problems.

Addition star

Where are they now?

Students are able to solve addition and subtraction questions by counting by ones.

Where to next?

Students are able to use a variety of non-count-by-one strategies to solve addition problems.

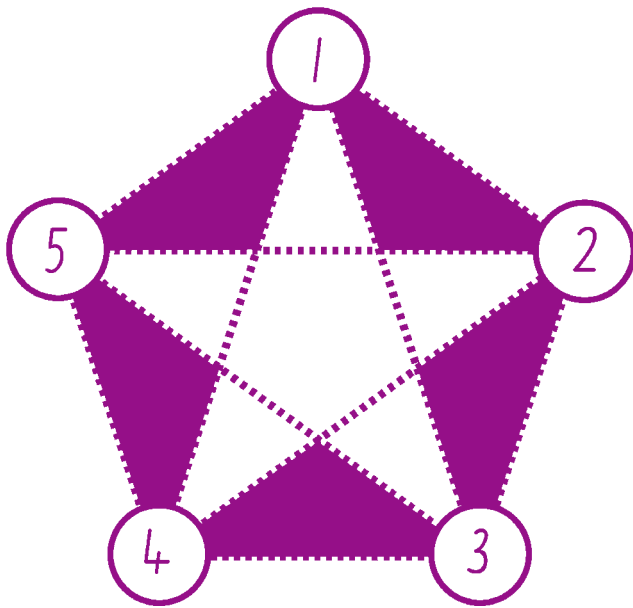

After playing the game, ask the students if they had any strategies for winning. If the students discover a strategy for always being able to bridge to the next decade, have them devise a rule to block the strategy.

Syllabus outcomes

NS2.2: Uses mental and written strategies for addition and subtraction involving two-, three- and four-digit numbers

WMS2.2: Selects and uses appropriate mental or written strategies, or technology, to solve problems

CMIT reference

Building addition and subtraction through grouping: facile counting strategies

BLM

Addition star, page 137

How?

Prepare a copy of *Addition star* BLM for each pair of students. The students will also need a counter and two dice. The students roll the dice and use the numbers that are rolled to indicate the target number. For example if a 5 and a 3 are rolled the students may choose to make the target number 53 or 35. Once the target number has been decided, the first player rolls one of the dice again and places the counter on the corresponding numeral on the addition star. If a “six” is rolled, the player may place the counter on any of the numerals. The second player then moves the counter along any line to add another number to the tally. If a player is able to add a number that bridges the total to the next decade, they have another turn. For example, student A starts at “five”. Student B moves to “one” and states the total, *Six!*. Player A moves the counter to “four” and states the total, *Ten! I made it to the decade so I have another turn!* The game continues until one player reaches the target number.

Variation

Start at the target number and subtract from the tally on each move. If a player moves down to the next decade, they have another turn.

Why?

Students need to know a variety of counting strategies to use and apply the most efficient strategy when solving arithmetical problems.

WR

Students record the target number and the additions.

Brainy fish

Where are they now?

Students are able to use counting-on as a strategy to solve addition problems.

Where to next?

Students are able to use a variety of strategies to solve addition problems including doubles, near doubles and combining numbers.

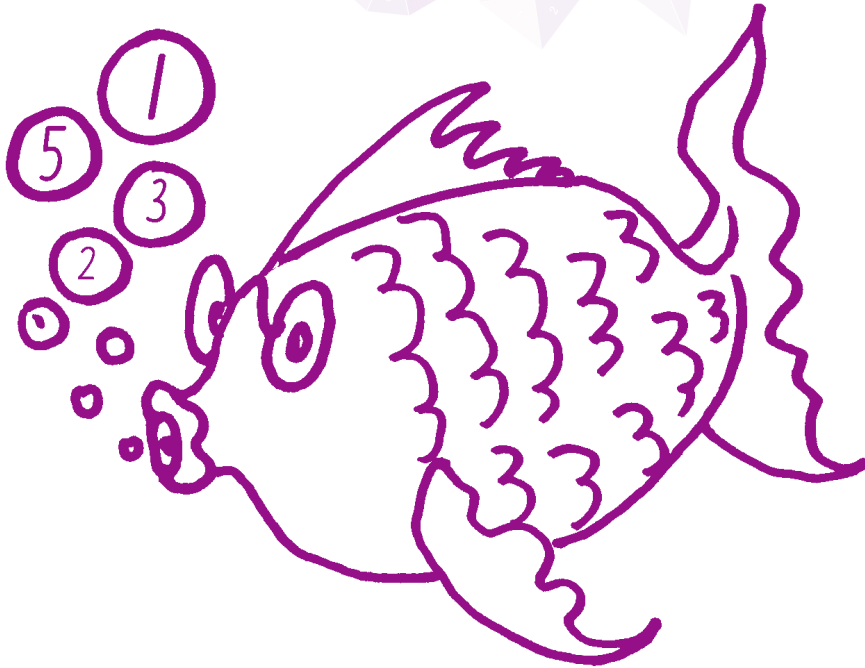

Syllabus outcomes

NS1.2: Uses a range of mental strategies and informal recording methods for addition and subtraction involving one- and two-digit numbers

WMS2.2: Selects and uses appropriate mental or written strategies, or technology, to solve problems

CMIT reference

Building addition and subtraction through grouping: facile counting strategies

BLM

Brainy fish, page 138

Brainy fish spinner, page 139

How?

Prepare a baseboard using *Brainy fish* BLM and a spinner displaying the following instructions: “Double it”, “Double it plus one”, “Double it take away one”, “How many more to make 10?” (Brainy fish spinner).

Organise the students into groups or pairs and provide them with a fish baseboard, a die and a supply of counters. Each student will need his or her own colour counters. Have the students take turns to firstly roll the die, then spin the instruction spinner. After following the instructions on the spinner, the student determines the answer and places his or her counter onto a corresponding numeral on the baseboard. More than one counter may be placed on a numeral. The activity continues until one student is able to place three counters in a row.

Why?

Students need to be able to apply a range of non-count-by one strategies in order to solve problems efficiently.



Use transparent counters so the numerals may be seen.

► Addition wheel pairs

Where are they now?

Students recall some double facts to 20.

Students count by ones when solving addition and subtraction problems.

Where to next?

Students are able to relate doubles to other number combinations.

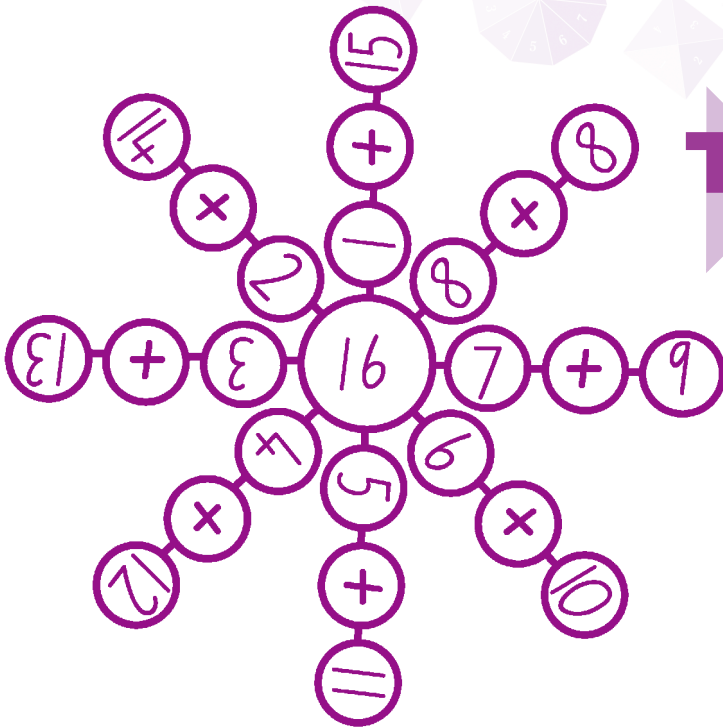

TP

Depending on the chosen double fact, not all spokes on the addition wheel may be needed or more spokes may be needed for a number larger than the example.

Syllabus outcomes

NS1.2: Uses a range of mental strategies and informal recording methods for addition and subtraction involving one- and two-digit numbers

WMS2.2: Selects and uses appropriate mental or written strategies, or technology, to solve problems

CMIT reference

Building addition and subtraction through grouping

Combining and partitioning: levels 1, 2

Recording symbols

BLM

Addition wheel pairs, page 140

How?

Provide the students with a copy of the addition wheel worksheet. Ask the students to nominate a “double” fact they know where the answer is bigger than ten. The students then write the total for the double fact on the centre of the wheel and the “doubles” combination on one of the spokes. Have the students add “one” to one of the numbers and take away “one” from the other number so that the total remains the same. The students then record the new number sentence on the next spoke of the wheel. Continue adding and subtracting “one” from the number sentence until all the spokes are filled. On the second wheel ask the students to add “ten” to the centre number and determine the addition combinations using the first wheel to help them. Discuss the similarities between the two wheels.

Variation

Ask the students to find partners who used the same number of spokes on the addition wheel and compare addition pairs.



Why?

Students need to develop a range of non-count-by-one strategies such as doubling and using known facts to derive an answer.

Singles or doubles?

Where are they now?

Students are able to use counting-on as a strategy to solve addition problems.

Where to next?

Students are able to use a variety of strategies to solve addition problems including doubles, near doubles and combining numbers.

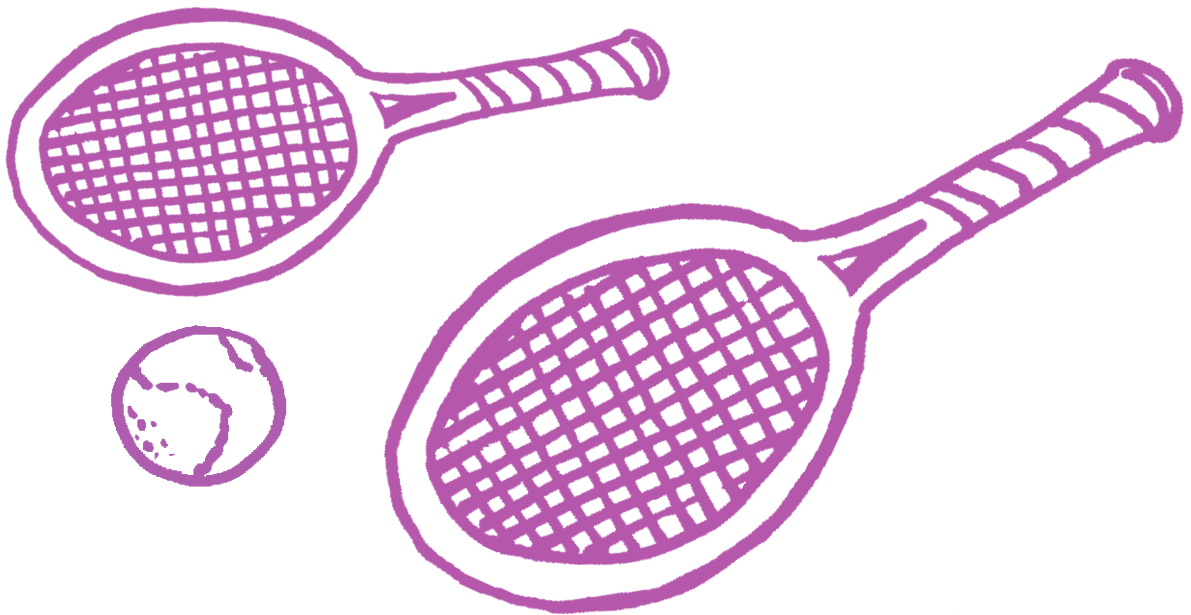

Syllabus outcomes

NS1.2: Uses a range of mental strategies and informal recording methods for addition and subtraction involving one- and two-digit numbers

WMS2.2: Selects and uses appropriate mental or written strategies, or technology, to solve problems

CMIT reference

Building addition and subtraction through grouping; facile counting strategies

How?

Prepare two dice, one displaying numerals 1–6 and the other marked S, S, S, D, D, D. “S” means the number rolled on the other dice remains as a “single” number. “D” means the number rolled on the other dice is doubled. Each student takes a turn to roll the dice and keeps a tally of his or her score. The first player to reach 100 is the winner.

Variation

Start with a score of 100 and subtract the rolled number.



Why?

Students need to develop a range of non-count-by-one strategies such as doubling and using known facts to derive an answer.

Even Stevens

Where are they now?

Students are able to use counting-on as a strategy to solve addition problems.

Where to next?

Students are able to use a variety of strategies to solve addition problems including doubles, near doubles and combining numbers.



Encourage the students to explain their solutions. Building numbers to 10 and 20 and doubling are useful strategies to model.

Syllabus outcomes

NS2.2: Uses mental and written strategies for addition and subtraction involving two-, three- and four-digit numbers

WMS2.2: Selects and uses appropriate mental or written strategies, or technology, to solve problems

CMIT reference

Building addition and subtraction through grouping: facile counting strategies

Combining and partitioning

Recording symbols

How?

Prepare nine cardboard squares and write the number “one” on three cards, the number “four” on three cards and the number “sixteen” on the remaining three cards. Place the cards into a box with a lid. Instruct the students to write the even numbers to 62 on a piece of paper. Have one of the students take a turn to shake the box and then turn it up so the cards fall to the floor. The student then adds up any cards that have landed face-up and if the sum is on his or her paper, crosses it off. The first player to cross off ten different numerals wins.

Variations

Have the students determine all of the numbers that can be created using the cards, prior to playing the game.

Students construct bingo boards with some of the even numbers to fifty recorded on each student’s board.

The first player to cross off five different numerals wins.

Provide the students with a hundred-chart. After the student has added the cards, he or she crosses off the corresponding number on the hundred-chart.

Use popsticks instead of numeral cards.

Why?

Students need to develop a range of non-count-by-one strategies such as *combining and partitioning* to derive an answer.

WR

When discussing strategies for solving addition problems, opportunities will arise to record students thinking. For example, a student may use a collection-based strategy for adding 16 and 16.

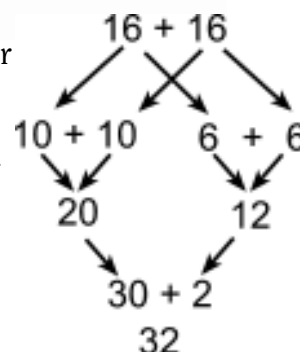

Engineer's dice

Where are they now?

Students are able to complete calculations using the four operations.

Where to next?

Students use a variety of mental strategies to solve problems involving the four operations and use their understanding of number concepts in a flexible way.

Syllabus outcomes

NS2.2: Uses mental and written strategies for addition and subtraction involving two-, three- and four-digit numbers

NS2.3: Uses mental and informal written strategies for multiplication and division

WMS2.2: Selects and uses appropriate mental or written strategies, or technology, to solve problems

CMIT reference

Building addition and subtraction through grouping: facile counting strategies

Combining and partitioning

Building multiplication and division through equal grouping: level 5

Recording symbols

How?

Provide each group of students with five dice. To play the game a target number is selected by the group. The students then take turns to roll the dice in the following way:

- Roll all five dice. Choose two of the dice and nominate an operation ($+$ $-$ \times \div) to carry out with the numbers rolled. Record the result. Discard these two dice.
- Roll the remaining three dice. Choose one number rolled, complete another operation ($+$ $-$ \times \div) with the chosen number and the first score. Discard that die.
- Roll the remaining two dice. Choose one number rolled and complete the same process as the step above using the current total.
- Roll the last die and complete the same process using the current total.

After each player has had his or her turn, the students compare their totals to see who is closest to the target score.

Variation

Change the operations that can be used. For example, doubling plus one.

Why?

Being able to calculate mentally is often quicker and easier than formal algorithms and can lead to a better understanding of number concepts such as place value and numerical operations.



Fancy dice

Where are they now?

Students are able to solve addition and subtraction questions by counting by ones.

Where to next?

Students are able to use a variety of non-count-by-one strategies to solve addition problems.

Syllabus outcomes

NS2.2: Uses mental and written strategies for addition and subtraction involving two-, three- and four-digit numbers

WMS2.2: Selects and uses appropriate mental or written strategies, or technology, to solve problems

CMIT reference

Building addition and subtraction through grouping: facile counting strategies

Combining and partitioning

Recording symbols

How?

Provide each group with five dice. Each student takes it in turn to roll the dice and add the total. The student continues to roll the five dice and accumulate the total unless a “two” or a “five” is rolled. If so, any dice displaying a “two” or a “five” must be taken out for all subsequent throws for that player. The student throws the remaining dice again and keeps going until he or she has no dice left. If “six” is rolled on two of the dice, the player loses all of the score for that turn and it is the next player’s turn. If “six” is rolled on three dice, the player loses all of his or her score, returning to zero and it is the next player’s turn. The first player to reach 200 wins.

Variation

Each player begins with a score of 200 and the total is subtracted from 100. The first player to reach zero is the winner.

Why?

Being able to calculate mentally is often more practical than completing formal algorithms. Students need to develop a range of mental strategies to apply to problem-solving situations.

WR

Each student will need to keep his or her own accumulating total. Have each student demonstrate to the group how the addition or subtraction was calculated.

Counter play

Where are they now?

Students are able to solve addition and subtraction questions by counting by ones.

Where to next?

Students are able to use a variety of non-count-by-one strategies to solve addition problems.

Syllabus outcomes

NS2.2: Uses mental and written strategies for addition and subtraction involving two-, three- and four-digit numbers

WMS2.2: Selects and uses appropriate mental or written strategies, or technology, to solve problems

CMIT reference

Building addition and subtraction through grouping: facile counting strategies

Combining and partitioning

Recording symbols

BLM

Counter play, page 141

How?

Organise the students into pairs and provide each pair with a copy of *Counter play* BLM, seven counters of one colour, say red, and one counter of another colour, say blue, and paper and pencil for scoring. Have the students lay out the counters so that the “blue” counter is on the top left hand corner of the grid and the “red” counters are on all other squares except the bottom right-hand corner. This corner does not begin with a counter on it. The aim is for the students to move the “blue” counter to the opposite corner keeping to the following rules:

- All moves must be vertical or horizontal.
- Only one counter must be on a square at any time.
- Take it in turns to move a counter.
- A player can only move one space at each turn.
- A player cannot uncover the same number twice in a row.

Players keep score by adding the number on the square the counter was moved from to their total. The player with the lowest score, when the “blue” counter is placed on the 6, wins.

Why?

Being able to calculate mentally is often more practical than completing formal algorithms. Students need to develop a range of mental strategies to apply to problem-solving situations.

WR

Have the students record and explain their methods for adding.



Copy that

Where are they now?

Students need to count each item to find the total.

Where to next?

Students are able to instantly recognise and state the total number of items in a small group.

Syllabus outcomes

NS1.1: Count, orders, reads and represents two- and three-digit numbers

WMS1.2: Uses objects, diagrams, imagery and technology to explore mathematical problems

CMIT reference

Subitising: perceptual

BLM

Copy that, page 142

How?

Prepare dot pattern flash cards for numbers up to seven (*Copy that* BLM). Provide each student with a pile of counters. Flash a domino pattern card to the students for about a second. Ask them to use their counters to reproduce the pattern. Discuss how many dots are in the pattern and how they remembered what the pattern looked like.

Variations

Ask the students to hold up the same number of fingers as the total of the dot pattern.

Use alternative material such as modelling dough to reproduce the dot patterns.

Display dot patterns on an overhead projector using transparent counters or cardboard with patterns cut-out or holes punched.

Why?

Recognising patterns instantly will assist students, to develop visualisation of numbers so as not to have to rely on counting perceived items. This contributes to early forms of grouping.

Using random patterns

Where are they now?

Students need to count each item to find the total.

Where to next?

Students are able to instantly recognise and state the total number of items in a small group (up to 6 or 7).



Make an art display with the dot patterns at the end of the activity.

Syllabus outcomes

NS1.1: Counts, orders, reads and represents two- and three-digit numbers

WMS1.2: Uses objects, diagrams, imagery and technology to explore mathematical problems

CMIT reference

Subitising: perceptual

How?

Have the students draw dot patterns onto cardboard squares for numbers three to eight. Tell them they are to draw a dot pattern for a different number on each card and that the dots can be in any arrangement they choose. With the overhead projector turned off, place a number of counters (from three to eight) onto the screen. These may be in random or traditional dot patterns. Briefly show the counters on the overhead. Each student then holds up a card showing the same number of dots as counters displayed on the overhead. Discuss how many counters were shown. Compare dot patterns.

Variations

Have students call out the number of counters on the overhead.

Have students call out how many to make ten.

Use the cards to play “memory match” games. (Matching a standard dot pattern to a random pattern.)

Why?

Recognising patterns instantly will assist students to develop visualisation of numbers so as not to have to rely on counting perceived items. This contributes to early forms of grouping.

Matching ten-frames

Where are they now?

Students need to count each item to find the total.

Where to next?

Students are able to instantly recognise and state the total number of items in a small group.

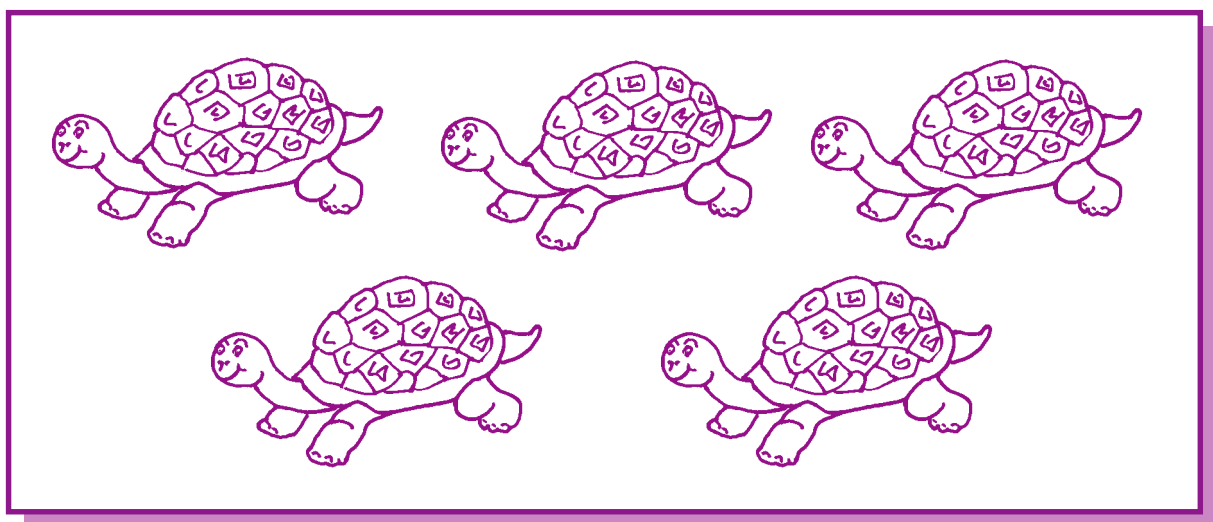

Syllabus outcomes

NS1.1: Counts, orders, reads and represents two- and three-digit numbers

WMS1.2: Uses objects, diagrams, imagery and technology to explore mathematical problems

CMIT reference

Subitising: perceptual

How?

Construct a set of flash cards displaying both random and standard dot patterns for numbers 1–7. (Cards could also be made of standard dot patterns for numbers 8–10.) Provide the students with a set of ten-frame cards displaying dots 1–10. Flash one of the dot pattern cards briefly. Have the students select a ten-frame card to match the number of dots on the flash card.

Variation

Replace the dots on the flash cards with simple pictures.

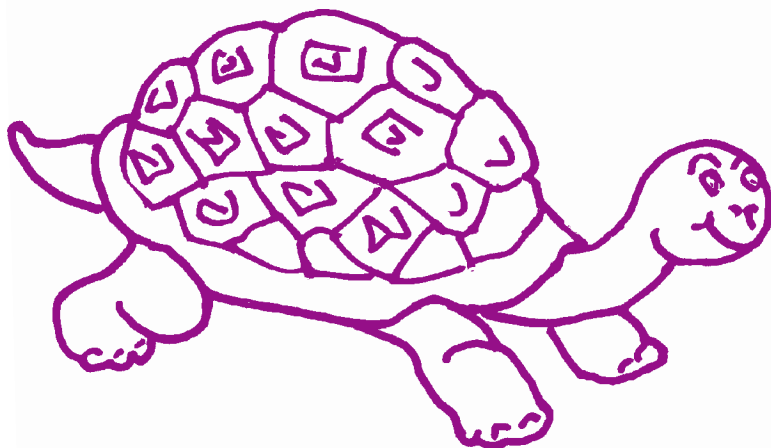

Why?

Recognising patterns instantly will assist students, to develop visualisation of numbers so as not to have to rely on counting perceived items. This contributes to early forms of grouping.

Bunches of five

Where are they now?

Students solve addition and subtraction tasks using count-by-ones strategies.

Where to next?

Students use grouping strategies to solve addition and subtraction tasks.



Syllabus outcomes

NS1.2: Uses a range of mental strategies and informal recording methods for addition and subtraction involving one- and two-digit numbers

CMIT reference

Combining and partitioning: To 10
Five as a sub-base

BLM

Bunches of five, page 143
Double scoops, page 144

How?

Provide each student with a copy of *Bunches of five* BLM. Each group will also need a die or spinner. Have the students take turns to roll the die. The student selects one of the pairs of hands on the worksheet and records the number underneath the hand(s). On the students next turn to roll, he or she may again choose any set of hands to add to. However, the student must roll the exact number to make ten to complete a set of hands. The winner is the first person to complete all sets of hands on the worksheet.

Variation

If needed, have students colour in the corresponding number of fingers for each turn.

Using the *Double scoops* BLM, the student rolls the die and records the number on a cone so that the two numbers added together equal ten.

Have six students out the front of the room to model the activity. As you roll and select a pair of hands, have the student put down the required number of fingers.

Why?

Developing an understanding that numbers can be regrouped into parts is essential if students are going to move beyond counting-by-ones as a counting strategy.

 **“Make ten” grids****Where are they now?**

Students solve addition and subtraction tasks using count-by-ones strategies.

Where to next?

Students use grouping strategies to solve addition and subtraction tasks.

Syllabus outcomes

NS1.2: Uses a range of mental strategies and informal recording methods for addition and subtraction involving one- and two-digit numbers

CMIT reference

Combining and partitioning: To 10, To 20

BLM

“Make ten” grids, page 145

How?

Organise the students into pairs. Provide each pair of students with a “Make ten” grid and a ten-sided die showing numerals 0–9. Have the students take turns to roll the die and call the number rolled. The student then states the number needed to make ten, finds the number on the grid and marks it with a cross or circle. Play continues until one player is able to mark off four numbers in a row.

Variations

Have the students create their own grids by writing numerals onto the blank grid.

Change the numbers on the grid so that the student makes combinations to equal twenty.

Why?

Developing an understanding that numbers can be regrouped into parts is essential if students are going to move beyond counting-by-ones as a counting strategy.

Memory of tens

Where are they now?

Students solve addition and subtraction tasks using count-by-ones strategies.

Where to next?

Students use grouping strategies to solve addition and subtraction tasks.

Syllabus outcomes

NS2.2: Uses mental and written strategies for addition and subtraction involving two-, three- and four-digit numbers

PAS2.1: Generates, describes and records number patterns using a variety of strategies and completes simple number sentences by calculating missing values

CMIT reference

Combining and partitioning

How?

Prepare two sets of cards in the range 0–10. Ensure each set is on different coloured card. Place the cards face down in front of the students. Have the students take turns to turn over a card from each set, trying to turn over two cards that combine to make 10. If the student is successful, they keep the pair of cards.

Replace one set of cards with a set of cards in the range 20–30. Have the students take turns to try to find two cards that combine to make 30.

Variations

Change the range of cards to 0–20.

Use ten-frame cards to represent numbers 0–10.

Why?

Developing an understanding that numbers can be regrouped into parts is essential if students are going to move beyond counting-by-ones as a counting strategy.

WR

Have the students record the number combinations that equal ten. Discuss how the students know that they have recorded all possible combinations. Then have the students record the combination that make 20 and 30.

Couple cups

Where are they now?

Students solve addition and subtraction tasks using count-by-ones strategies.

Where to next?

Students use grouping strategies to solve addition and subtraction tasks.



Note the strategies students use to tally the numbers.

Syllabus outcomes

NS1.2: Uses a range of mental strategies and informal recording methods for addition and subtraction involving one- and two-digit numbers

PAS1.1: Creates, represents and continues a variety of number patterns, supplies missing elements in a pattern and builds number relationships

CMIT reference

Combining and partitioning: To 10

How?

Decorate ten paper cups with bright patterns. Place the cups on the floor and without the students seeing, hide a different number, from 1–9 (not in sequence) of plastic teddies, under each cup. Two cups will need five teddies under each. Teddies could be substituted with marbles, counters, buttons or other suitable material. When the material is ready have the students take turns to lift two cups. As soon as the number of teddies under the first cup has been determined, the student is to state that number and the number needed to make ten before lifting the second cup. If the total is ten the student keeps the teddies and returns the cups. If the total is not ten, the student replaces the cups over the teddies.

Variations

Record the number combinations.

If the student chooses two cups that add to ten, they replace the cups and the teddies in a different location. When they put the teddies back they must share the ten teddies in a different combination from the one they found. The same cups may not be chosen for at least two turns.

Why?

Developing an understanding that numbers can be regrouped into parts is essential if students are going to move beyond counting-by-ones as a counting strategy.



Nine piles

Where are they now?

Students solve addition and subtraction tasks using count-by-ones strategies.

Where to next?

Students use grouping strategies to solve addition and subtraction tasks.

Syllabus outcomes

NS1.2: Uses a range of mental strategies and informal recording methods for addition and subtraction involving one- and two-digit numbers

PAS1.1: Creates, represents and continues a variety of number patterns, supplies missing elements in a pattern and builds number relationships

CMIT reference

Combining and partitioning: To 10

How?

Remove the “picture” and “ten” cards from a deck of playing cards. For this activity ensure the students know that the “Ace” is equivalent to “one”. Deal out the cards face up into nine piles. The students take turns to locate two cards that total to ten. If able to find two cards equalling ten, the student removes and keeps the cards, revealing two new cards. The activity continues until a player is unable to pair-up two cards that total ten.

Variations

For this activity tell the students that the “Ace” is now equivalent to “eleven” for this activity and have them locate and remove cards that total twenty. This may be two or more cards at one turn.

Why?

Developing an understanding that numbers can be regrouped into parts is essential if students are going to move beyond counting-by-ones as a counting strategy.

▶ Number chop

Where are they now?

Students solve addition and subtraction tasks using count-by-ones strategies.

Where to next?

Students use grouping strategies to solve addition and subtraction tasks.

Syllabus outcomes

NS1.2: Uses a range of mental strategies and informal recording methods for addition and subtraction involving one- and two-digit numbers

PAS1.1: Creates, represents and continues a variety of number patterns, supplies missing elements in a pattern and build number relationships

CMIT reference

Combining and partitioning: To 20

Recording symbols

How?

Provide the students with 20 “unifix” cubes. Ask the students to choose a number between 11 and 20 and to link a corresponding number of cubes together. Tell the students to “break” the cubes into two groups and record the combination. Have the students determine and record all possible combinations. Next have the students complete the same process for a different number without using the unifix cubes.

Why?

Developing an understanding that numbers can be regrouped into parts is essential if students are going to move beyond counting-by-ones as a counting strategy.

WR

Have the students record the addition combinations and then determine how the numbers could be used to show subtraction facts.

Number draughts

Where are they now?

Students solve addition and subtraction tasks using count-by-ones strategies.

Where to next?

Students use grouping strategies to solve addition and subtraction tasks.

Syllabus outcomes

NS1.2: Uses a range of mental strategies and informal recording methods for addition and subtraction involving one- and two-digit numbers

PAS1.1: Creates, represents and continues a variety of number patterns, supplies missing elements in a pattern and builds number relationships

CMIT reference

Combining and partitioning: To 20

BLM

Number draughts, page 146

How?

Prepare a 5 x 4 grid baseboard and a set of numeral cards showing numbers 1–9 and 11–20 and a star card for each pair of students. Have the students shuffle the cards and place them in random order face-up onto the 20 sections of the baseboard. To play, the students take turns to move one card vertically, horizontally or diagonally one space, onto another card with the aim of making a total of 20 with the two cards. If the cards total 20 the player keeps the cards. If a pair cannot be made the player may move any card into an adjoining space in preparation for a later move.

The “20” and “★” cards are “wild”. The “20” card may be picked up on its own and kept but can only be taken if no other pairs can be made. The “★” card may represent any number. The student may pair it with any adjoining card. However, it can only be used if no other pairs can be made and the student using it must indicate the value it takes.

Variation

Students move a card by jumping over another card vertically, horizontally or diagonally.

Why?

Developing an understanding that numbers can be regrouped into parts is essential if students are going to move beyond counting-by-ones as a counting strategy.



Count-off

Where are they now?

Students know the sequence of counting forwards and backwards by tens.

Where to next?

Students are able to count forwards and backwards by tens, both on and off the decade.

Syllabus outcomes

NS1.1: Counts, orders and represents two- and three-digit numbers

CMIT reference

Counting by 10s and 100s: level 2
Recording symbols

How?

Roll a ten-sided (decahedron) or a twelve-sided (dodecahedron) die. Have the students start counting from the number rolled, adding ten to the count each time up to the 90s. Then count backwards by tens.

Display a hundred chart to the students. Have one student select a number from 1–9 on the hundred chart and call out the number. Once the student calls out the selected number, the rest of the class continue counting by adding ten each time. The first student may continue to locate each number after it has been called.

Why?

Developing knowledge of forwards and backwards counting skills will assist students in using mental calculations to solve two-digit addition and subtraction tasks.

WR

The “empty number line” could be used to record student’s thinking and to demonstrate building-on by tens.

Number line counting

Where are they now?

Students know the sequence of counting forwards and backwards by tens.

Where to next?

Students are able to count forwards and backwards by tens, both on and off the decade.

Syllabus outcomes

NS1.1: Counts, orders and represents two- and three-digit numbers

CMIT reference

Counting by 10s and 100s: level 2

How?

Display a 0–100 number line to the students. Ask a student to nominate a single-digit number from which to begin counting. Encourage the students to count along the line for ten counts from the nominated number. Attach a peg, or paperclip, to the last number of the count. Continue by counting on ten more each time and marking the last number counted. Chant the sequence of “marked” numbers. Repeat the process, starting from a different single-digit. After a few turns, discuss other sequences without having to mark each number first.

Why?

Developing knowledge of forwards and backwards counting skills will assist students in using mental calculations to solve two-digit addition and subtraction tasks. Students need to be able to count by tens from the middle of the decade to use the “jump” method to solve addition problems. This involves starting from one number and adding on by tens and ones.

WR

Show how these findings could be represented on an “empty number line”.

Hands up

Where are they now?

Students know the sequence of counting forwards and backwards by tens.

Students use their fingers to count on by ones when solving addition problems.

Where to next?

Students are able to count forwards and backwards by tens, both on and off the decade and use this strategy to solve addition problems.



This activity could be used to demonstrate the *jump method* of adding two, two-digit numbers.

Jump method: When adding two numbers, the student starts counting from one number and adds firstly the “tens” and then the “ones” from the second number to find the total.

Syllabus outcomes

NS1.1: Counts, orders and represents two- and three-digit numbers

NS1.2: Uses a range of mental strategies and informal recording methods for addition and subtraction involving one-, and two-digit numbers

CMIT reference

Counting by 10s and 100s: level 1 and 2

Building place value through grouping: level 1

Finger strategies

Recording symbols

How?

Ask a student to come to the front of the class and hold up ten fingers. Then ask the student to demonstrate a number such as “43” using fingers. If the student is hesitant, suggest that friends may help in the demonstration by raising their fingers as well. Ask the class to check the number of fingers by counting groups of tens and then adding the ones. Then ask the class to check the number again, this time by counting from the “ones” first and then counting on by “tens”. In the example of “make 43” the counting sequence would be 10, 20, 30, 40, 41, 42, 43 and then 3, 13, 23, 33, 43. Repeat with various other numbers. When the class is confident in representing numbers in this way, expand the activity to representing two numbers and adding them together.

Variation

Have one student represent a two-digit number using as many students’ hands as needed, without stating what the number is. Each member of the class then determines and records the number.

Why?

Developing knowledge of forwards and backwards counting skills will assist students in using mental calculations to solve two-digit addition and subtraction tasks. Students need to be able to count by tens off the decade to be able to use the “jump” method for solving addition problems.

WR When students are using fingers to form a number, record the numeral on the chalkboard and discuss the number of tens and ones and how they are used to form the number.

Have students use informal recordings on the chalkboard to demonstrate their methods of solving the additions.

An empty number line could be used to record the *jump* procedure.



Sticks of ten

Where are they now?

Students know the sequence of counting forwards and backwards by tens.

Students use their fingers to count on by ones when solving addition problems.

Where to next?

Students are able to count forwards and backwards by tens, both on and off the decade and use this strategy to solve addition problems.

Syllabus outcomes

NS1.1: Counts, orders and represents two- and three-digit numbers

NS1.2: Uses a range of mental strategies and informal recording methods for addition and subtraction involving one- and two-digit numbers

CMIT reference

Counting by 10s and 100s: level 1 and 2

Building place value through grouping: level 1

Recording symbols

How?

Ask two students to come to the front of the class. Have ten sticks of ten unifix cubes and give five sticks to one student and five to the other. Ask one of the students to break off some of the cubes from one of the sticks and give it to the other student. Both students display their sticks. Have the class count the number of cubes the first student has and then use the second student's sticks to count on by tens and then ones to reach 100.

Variations

Once the class has determined how many cubes the first student has, ask them to work out how many the second student has without seeing the cubes.

Have the first student break off more than ten cubes and give them to the second student.

Why?

Developing knowledge of forwards and backwards counting skills will assist students in using mental calculations to solve two-digit addition and subtraction tasks. Students need to be able to count by tens off the decade to be able to use the “jump” method for solving addition problems.



Have the students record their working when solving the missing addend task.

Bean counter

Where are they now?

The student counts on by ones when solving two-digit addition questions. The student does not treat ten as a composite unit for counting but rather as ten single units.

Where to next?

The student treats ten as a composite unit and can solve two-digit addition and subtraction questions by counting by tens and ones.

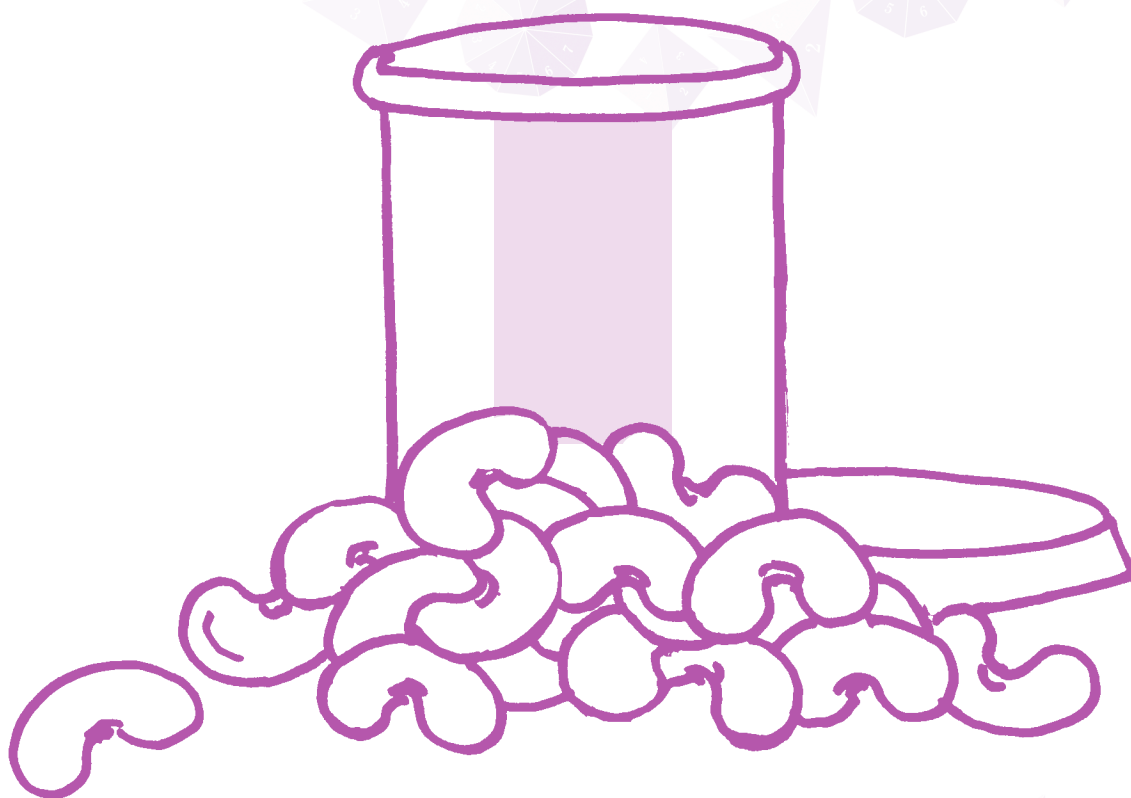

Syllabus outcomes

NS2.1: Counts, orders, reads and records numbers up to four digits

WMS2.2: Selects and uses appropriate mental or written strategies, or technology, to solve problems

CMIT reference

Building place value through grouping: level 1

How?

Present the students with a large quantity of dry beans or other similar material that can be stored in small containers. Ask students to estimate the number of beans. Have the students count out ten beans and place the beans into a container such as a film canister. Students continue until all beans have been placed into groups of ten. Encourage the students to find the total number by counting by tens and then adding any remaining single units.

Variation

Count the remaining beans first and then count on by tens to find the total.

Why?

Reorganising single units into groups of “ten” assists students to see ten as a composite unit. This understanding will aid students’ knowledge of place value.

WR

Record the total number for each material. Discuss the unit structure of ones, tens and hundreds. For example, if the total is 102, record how many tens and units make up the total.

Dizzy dots

Where are they now?

The student counts on by ones when solving two-digit addition questions. The student does not treat ten as a composite unit for counting but rather as ten single units.

Where to next?

The student treats ten as a composite unit and can solve two-digit addition and subtraction questions by counting by tens and ones.



Lead the students to counting by fives and tens.

Syllabus outcomes

NS2.1: Counts, orders, reads and records numbers up to four digits

PAS2.1: Generates, describes and records number patterns using a variety of strategies and completes simple number sentences by calculating missing values

WMS2.4: Checks the accuracy of a statement and explains reasoning used

CMIT reference

Building place value through grouping: level 1

BLM

Dizzy dots, page 147

How?

Present the students with various large arrays arranged in rows of five or ten. A 10 x 10 array is included in the BLM section. This can be used to create different array patterns, e.g. 5 x 10. Ask the students to think of a way to count the dots quickly and easily to determine the total. The hundred-chart could be used to assist students with counting.

Why?

Reorganising single units into groups of “ten” assists students to see ten as a composite unit. This understanding will aid students’ knowledge of place value.

Building numbers with ten-frames

Where are they now?

The student counts on by ones when solving two-digit addition questions. The student does not treat ten as a composite unit for counting but rather as ten single units.

Where to next?

The student treats ten as a composite unit and can solve two-digit addition and subtraction questions by counting by tens and ones.



Make ten ten-frame cards from the blank BLM. Leave one card blank and the rest to represent a number from 1–9.

Syllabus outcomes

NS2.1: Counts, orders, reads and records numbers up to four digits

WMS2.2: Selects and uses appropriate mental or written strategies, or technology, to solve problems

CMIT reference

Building place value through grouping: level 1

Numeral identification: level 3

BLM

Ten-frame, page 148

How?

Present the students with two piles of numeral cards displaying numerals 0–9 and a supply of ten-frame cards. The students will require nine “full” ten-frame cards and one of each ten-frames showing 1–9 dots. Have the students draw a numeral card from each pile and construct a two-digit number. The students then represent the numeral using the ten-frame cards.

23

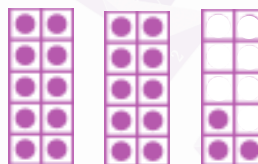

Ask the students to indicate how many more are needed to reach the next decade.

Variation

Provide the students with additional ten-frame cards and numeral cards. Pose addition problems for the students to solve. Have the students use the ten-frame cards to represent the numbers and to solve the problems.

Why?

Part of the sequence of developing an understanding of place value moves from students seeing ten as a composite unit to students using tens and ones to find the total of two, two-digit numbers.

WR

The ten-frames could be used to introduce written algorithms by writing the number the ten-frame represents under each frame.

Hundred chart windows

Where are they now?

The student counts on by ones when solving two-digit addition questions. The student does not treat ten as a composite unit for counting but rather as ten single units.

Where to next?

The student treats ten as a composite unit and can solve two-digit addition and subtraction questions by counting by tens and ones.

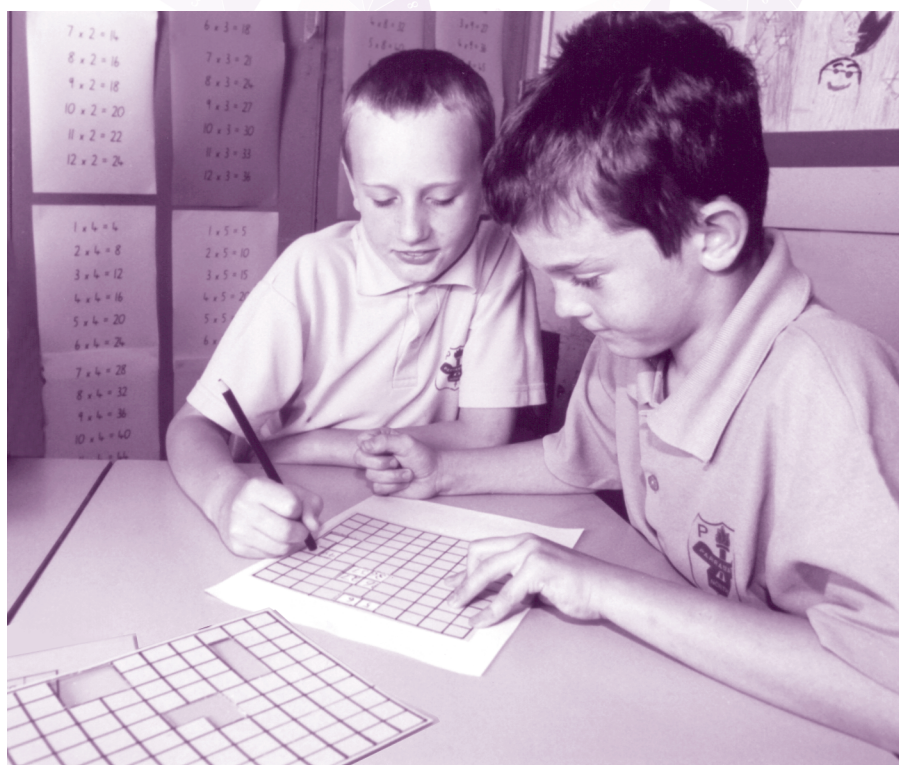

Syllabus outcomes

NS2.1: Counts, orders, reads and records numbers up to four digits

WMS2.2: Selects and uses appropriate mental or written strategies, or technology, to solve problems

CMIT reference

Building place value through grouping: level 1

Numeral identification: level 3

BLM

Hundred chart windows, page 149

Hundred chart windows sample, page 150

How?

Provide the students with a hundred chart grid. Prepare a second hundred chart grid card which will fit onto the first card. Cut “windows” out of the second grid card. For example, cut out a window covering four squares on the grid. Have the students place the “window card” on top of the grid and using the grid to assist them, determine which numbers on the hundred chart should be recorded in each square of the window. Three or four windows should be cut out of each “window card”. Have the students rotate the window card 90° to reveal new boxes on the hundred chart grid. Students need to rotate the card three times and repeat the process of recording the missing numbers. An adequate supply of window cards will need to be prepared, enabling all numbers to be recorded on the grid. (An example of window cards is included in the BLM section.)

Variation

Have a card with only one square cut out and place it on top of a hundred chart. Instruct the students to place the card on a starting number and then to add on a nominated amount by moving the card down by tens and across by ones.

Why?

Reorganising single units into groups of “ten” assists students to see ten as a composite unit. This understanding will aid students’ knowledge of place value.



Practice locating numbers on a 1–100 chart by counting by tens and ones prior to this activity.

Money problems

Where are they now?

The student counts on by ones when solving two-digit addition questions. The student does not treat ten as a composite unit for counting but rather as ten single units.

Where to next?

The student treats ten as a composite unit and can solve two-digit addition and subtraction questions by counting by tens and ones.



After practising counting by tens, on and off the decade, move to hundreds and tens, on and off the decade.



Syllabus outcomes

NS2.1: Counts, orders, reads and records numbers up to four digits

NS2.2: Uses mental and written strategies for addition and subtraction involving two- and three-digit numbers

WMS2.2: Selects and uses appropriate mental or written strategies, or technology, to solve problems

CMIT reference

Counting by 10s and hundreds: level 2

Building place value through grouping: level 1

How?

Provide the students with a collection of ten-cent coins (or play money). Nominate a starting amount, say 30 cents, and ask the students to use the coins to determine how much more is needed to equal \$1.00.

Variations

Nominate a starting amount that is off the decade, say 25 cents. Provide the students with the necessary coins to enable them to count by tens and then bridge to one hundred to determine the amount needed to total \$1.00.

Present the student with six, five-cent coins, five, ten-cent coins, four, twenty-cent coins and two, fifty-cent coins. Ask the students to determine as many different ways as they can to make up \$1.00 using the coins. Have the students record the combinations.



Why?

Knowledge of forward and backward counting sequences by tens, both on and off the decade, will assist students with mental strategies when solving addition and subtraction problems.

Four turns to 100

Where are they now?

The student counts on by ones when solving two-digit addition questions. The student does not treat ten as a composite unit for counting but rather as ten single units.

Where to next?

The student treats ten as a composite unit and can solve two-digit addition and subtraction questions by counting by tens and ones.



Demonstrate the use of the empty number line prior to this activity.

Syllabus outcomes

NS2.2: Uses mental and written strategies for addition and subtraction involving two-, three- and four-digit numbers

WMS2.2: Selects and uses appropriate mental or written strategies, or technology, to solve problems

CMIT reference

Building place value through grouping: level 1

How?

Organise the students into groups of four. Provide each group of students with a pack of cards in the range 1 to 9. Each player draws a card from the deck and decides if the number they have drawn will represent ones or tens. For example, if a five is drawn it can represent five or fifty. The players take a second draw from the pack, again nominating if the number represents tens or ones and adds the number to their first card. Have the students record their total on an empty number line. Continue the activity until each student has drawn four cards. The player with the highest total not exceeding 100 wins.

Variations

Players start at 100 and subtract the numbers, after nominating if the number drawn represents tens or ones. The player closest to zero is the winner.

Players draw two numbers from the pile and make the highest two-digit number possible. This becomes their starting number and they continue to play as in the above variation.

Why?

In solving addition and subtraction problems, students need access to a range of strategies other than counting by ones.

Eggsactly

Where are they now?

The student counts on by ones when solving two-digit addition questions. The student does not treat ten as a composite unit for counting but rather as ten single units.

Where to next?

The student treats ten as a composite unit and can solve two-digit addition and subtraction questions by counting by tens and ones.



Syllabus outcomes

NS2.2: Uses mental and written strategies for addition and subtraction involving two-, three- and four-digit numbers

WMS2.2: Selects and uses appropriate mental or written strategies, or technology, to solve problems

CMIT reference

Building place value through grouping: level 1

BLM

Eggsactly, page 151

How?

Prepare empty egg cartons by writing a numeral in the range 0–9 inside each of the cups. Place two counters into the egg carton. Provide each group or pair of students with the prepared egg carton, a pack of cards displaying numerals 0–9 and a supply of tens-strips and single-unit strips. Have the students take turns to shake the carton and open it to see which two numbers the counters have landed on. The student decides in which order the numbers will be used to make a two-digit number and then represents the number using the number cards. The student repeats the action and this time represents the two-digit number using the ten-strips and single-dot strips. The student then adds the two numbers together to determine the total and records the answer. Encourage the students to state how they added the numbers. The partner or group members should agree with the total before it is recorded.

Why?

In solving addition and subtraction problems, students need access to a range of strategies other than counting by ones.

Cover-up strips

Where are they now?

The student counts on by ones when solving two-digit addition questions. The student does not treat ten as a composite unit for counting but rather as ten single units.

Where to next?

The student treats ten as a composite unit and can solve two-digit addition and subtraction questions by counting by tens and ones.



Encourage the students to tell their partner how they are combining the numbers.

Syllabus outcomes

NS2.2: Uses mental and written strategies for addition and subtraction involving two-, three- and four-digit numbers

WMS2.2: Selects and uses appropriate mental or written strategies, or technology, to solve problems

CMIT reference

Building place value through grouping: level 1

Combining and partitioning

BLM

Hundred chart, page 152

Cover-up strips, page 153

How?

Provide each pair of students with two dice, a hundred chart and a set of “cover-up” strips. To begin the activity the first student rolls the two dice, states the total and represents this total on the hundred chart using the strips. The activity continues with each student taking turns to roll the two dice and adding the number rolled to the previous total. Each time a new total is made the student must represent the total with strips on the hundred chart. This will involve the students regrouping the numbers and replacing some of the strips with appropriate combinations. For example, if a nine was originally rolled and then twelve was added to the total, the student would replace the strips representing the nine with a “twenty” strip and a “one” to represent the new total of twenty-one. Play continues until the entire hundred chart is covered. The last roll must make exactly 100.

Variation

Begin with the hundred chart covered with the strips. Have the students roll the two dice and subtract the amount from 100. The student would then remove the appropriate number of strips. Strips may need to be replaced as new combinations are made.

Why?

In solving addition and subtraction problems, students need access to a range of strategies other than counting by ones.

Tracks

Where are they now?

The student counts on by ones when solving two-digit addition questions. The student does not treat ten as a composite unit for counting but rather as ten single units.

Where to next?

The student treats ten as a composite unit and can solve two-digit addition and subtraction questions by counting by tens and ones.



Model how to count backwards and forwards by tens and ones on a hundred chart prior to the students completing this activity in pairs.

Syllabus outcomes

NS2.2: Uses mental and written strategies for addition and subtraction involving two-, three- and four-digit numbers

WMS2.2: Selects and uses appropriate mental or written strategies, or technology, to solve problems

WMS2.1: Asks questions that could be explored using mathematics in relation to Stage 2 content

CMIT reference

Building place value through grouping: level 1

BLM

Tracks, page 154

How?

Organise the students into pairs and provide them with a copy of *Tracks* BLM, a set of numeral cards 0–9 and a hundred chart. Have the students take turns to draw two cards from the deck to make a two-digit number. The student who has drawn the cards records this number on the “Tracks” sheet as their starting number. The partner then fills in the boxes on the sheet with three directional arrows. These arrows indicate if the student is to:

- ↑ count back by ten from the number
- ↓ count on by ten
- ⇒ add on one
- ⇐ take away one.

The first student locates the starting number on the hundred chart and follows the directional arrows to determine the number they would finish on.

For example, if the starting number is 24 and the directional arrows were, ↓, ↓, ⇒, then the finishing number would be 45.

Variations

Have the students complete the activity on a blank hundred chart.

Use a numbered 1–100 chart and a blank die marked with directional arrows. Both students place a counter on number 45 and take turns to roll the die and move their counter accordingly. The winner is the first to reach 1 or 100.

Use ↖ and ↗ to represent -11 and $+11$.

Why?

In solving addition and subtraction problems, students need access to a range of strategies other than counting by ones including counting by tens from the middle of the decade.

▶ Hundred chart jigsaw

Where are they now?

The student counts on by ones when solving two-digit addition questions. The student does not treat ten as a composite unit for counting but rather as ten single units.

Where to next?

The student treats ten as a composite unit and can solve two-digit addition and subtraction questions by counting by tens and ones.



Copy the master sheet onto cardboard for easier handling.

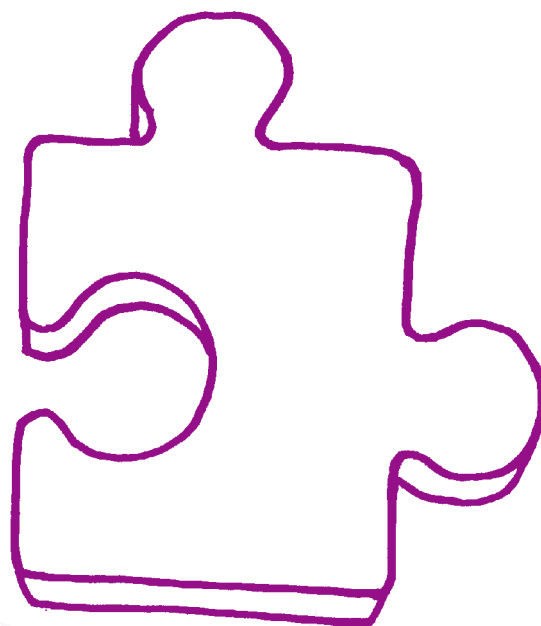

Syllabus outcomes

NS2.1: Counts, orders, reads and records numbers up to four digits

WMS2.2: Selects and uses appropriate mental or written strategies, or technology, to solve problems

CMIT reference

Building place value through grouping: level 1

Numeral identification: level 3

BLM

Hundred chart jigsaw, page 155

How?

Organise the students into pairs and provide them with a copy of the *Hundred chart jigsaw* BLM. Have the students fill in the missing numbers on the chart by either subtracting or adding by tens and ones. The students then cut out the jigsaw pieces and fit them together to form a hundred chart.

Variation

Have the students reconstruct the hundred chart without filling in the missing numbers.

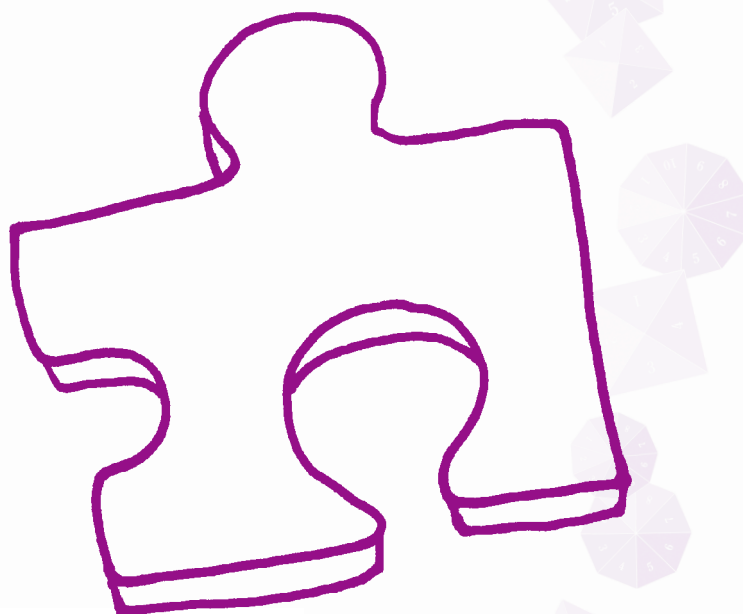

Why?

In solving addition and subtraction problems, students need access to a range of strategies other than counting by ones including counting by tens from the middle of the decade.

Teeny tiny ten-frames

Where are they now?

The student counts on by ones when solving two-digit addition questions. The student does not treat ten as a composite unit for counting but rather as ten single units.

Where to next?

The student treats ten as a composite unit and can solve two-digit addition and subtraction questions by counting by tens and ones.

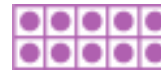
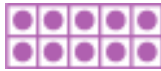
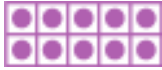
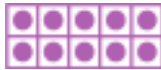
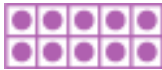

Syllabus outcomes

NS2.1: Counts, orders, reads and records numbers up to four digits

NS2.2: Uses mental and written strategies for addition and subtraction involving two-, three- and four-digit numbers

WM2.3: Uses appropriate terminology to describe, and symbols to represent, mathematical ideas

CMIT reference

Building place value through grouping: level 1

Numeral identification: level 3

BLM

Teeny tiny ten-frames, page 156

How?

Provide the students with a set of *Teeny tiny ten-frames*. Nominate a two-digit number and ask the students to represent the number using the ten-frames. Have the students share how they made the number. Ask the students to make a second two-digit number. Repeat the questioning. Have the students find the total of the two numbers using the ten-frames. Discuss how they solved the addition.

Variation

Make the first number and then cover it up. Make the second number and use the material to determine the total of both numbers.

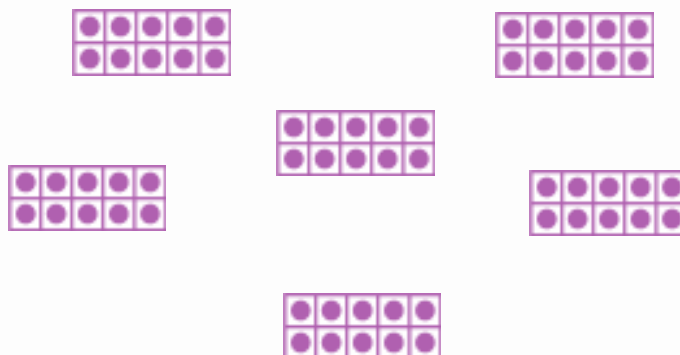

Why?

Place value concepts need to be developed through its use in mental addition and subtraction.

W
R

Record students' thinking as they discuss the strategies used to solve the additions.

► Teddy tummies: multiplication

Where are they now?

Students can form groups by one-to-one dealing.



Where to next?

Students use equal grouping and perceptual skip counting to find the total of groups.



Syllabus reference

NS1.3: Uses a range of mental strategies and concrete materials for multiplication and division

PAS2.1: Generates, describes and records number patterns using a variety of strategies and completes simple number sentences by calculating missing values

WMS2.2: Selects and uses appropriate mental or written strategies, or technology, to solve problems

CMIT reference

Building multiplication and division through equal grouping and counting: level 1, 2

BLMs

Teddy tummies, page 157

Hundred chart, page 152

How?

Provide pairs of students with a *Teddy tummies* baseboard, 30 transparent coloured counters and a worksheet displaying numerals 1–30. Ask the students to share the counters among the teddies and mark each numeral on the worksheet with a cross as the counters are distributed. When the students are able to form equal groups on each of the teddies, (i.e. each time all teddies contain the same number of counters), have them circle the number on the worksheet instead of marking it with a cross.

Have the students count the numbers from 1–30, first with a rhythmic count (saying all numbers and stressing the circled numbers) and then using a skip count (saying only the multiples 3, 6, 9 ...).

Provide the students with a hundred chart. Ask the students to place the counters on the hundred chart that correspond to the numerals they have circled on the worksheet. Have the students identify and discuss the number pattern for multiples of three and then continue the pattern on the hundred chart.

Variations

Change the number of teddies on the worksheet to work with multiples other than three.

After the students have completed the pattern on the hundred chart, pose questions such as: *Which number have you covered with your fourth counter?* (12) *What does this mean?* Discuss the fact that this means $4 \times 3 = 12$. Close your eyes. *What number do you think will be covered by the tenth counter? Why?* (Note that the expression “covered by” is less likely to cause confusion than “under”. Some students may think that 22 is “under” the fourth counter, because 22 is “under” (below) 12 on the hundred chart.

Why?

A student may be able to form equal groups yet not be able to calculate the total of the groups in an organised way. Using a skip count will assist students in finding the total and in visualising composite units.

People markers

Where are they now?

Students are able to use material to form equal groups and find the total by counting by ones.

Where to next?

Students find the total of groups by using a rhythmic or skip count.

Syllabus reference

NS1.3: Uses a range of mental strategies and concrete materials for multiplication and division

PAS2.1: Generates, describes and records number patterns using a variety of strategies and completes simple number sentences by calculating missing values

WMS2.2: Selects and uses appropriate mental or written strategies, or technology, to solve problems

CMIT reference

Building multiplication and division through equal grouping and counting: level 1 and 2

Recording symbols

BLM

Ten-frame, page 148

How?

Prepare ten, ten-frame cards, each displaying the number of dots for the multiple to be practised. For example, each ten-frame has three dots. Distribute the ten-frame cards to the students. Ask a student to call out a number in the range 1–10. Select a corresponding number of students to bring their ten-frame cards to the front of the class. Have the class find the total number of dots by firstly using rhythmic counting and then repeat using skip counting. Record the number pattern on the board when all ten, ten-frames are used.

Why?

To develop students' concepts of multiplication and division, we need to provide strategies that focus on groups of items rather than individual items. Rhythmic and skip counting help students to focus on groups within the whole.

WR

A flip strip could be used to record the number pattern.

Counter grab: multiplication

Where are they now?

Students are able to model equal-sized groups and find the total by counting by ones.

Where to next?

Students use skip counting to determine the total of groups and any remainders.

Syllabus reference

NS2.3: Uses mental and informal written strategies for multiplication and division

PAS2.1: Generates, describes and records number patterns using a variety of strategies and completes simple number sentences by calculating missing values

WMS2.2: Selects and uses appropriate mental or written strategies, or technology, to solve problems

CMIT reference

Building multiplication and division through equal grouping and counting: level 1 and 2

BLM

Counter grab, page 158

How?

Provide students with a small container of counters and a copy of *Counter grab* BLM. Instruct the students to take turns to grab a handful of counters, or other suitable material, and place them on the floor or table. Have the students firstly estimate how many counters there are and then organise the counters into groups of a nominated number, for example, groups of three. Encourage the students to determine the total by using rhythmic or skip counting. Discuss what happens when there are counters left over. On the worksheet, students record their estimate, the number of groups, the number of counters in each group, any remainders and the total. Model stress and skip counting to find the total.

Variation

Have the students make different equal groups from the one handful of counters and record the combinations.

Why?

Using a skip count will assist students in finding the total and in visualising composite units. Students should also be given opportunities to work on problems that involve remainders.

Create an array

Where are they now?

Students are able to form equal groups and find the total by counting by ones.

Where to next?

Students use skip counting to determine the total of the groups.



Discuss the arrays in terms of both multiplication and division.

Syllabus outcomes

NS2.3: Uses mental and informal written strategies for multiplication and division

PAS2.1: Generates, describes and records number patterns using a variety of strategies and completes simple number sentences by calculating missing values

WMS2.2: Selects and uses appropriate mental or written strategies, or technology, to solve problems

CMIT reference

Building multiplication and division through equal grouping: level 2 and 3

BLM

Dizzy dots, page 147

How?

Explain the term “array” to the students and provide them with a 10 x 10 array and two sheets of paper. Use an overhead projector or large chart to demonstrate how the 10 x 10 array can be covered with two pieces of paper to form other arrays. For example, cover the top three rows with paper and the first five columns with another piece of paper to form a 7 x 5 array (7 rows with 5 in each row).

Ask the students to use their arrays sheets and paper to make nominated arrays. Have the students use skip counting of the rows to determine the answer.

Variations

Ask the students to form arrays that have a nominated number of dots, say 24. Record the arrays the students have constructed. 6 x 4, 4 x 6, 3 x 8, 8 x 3.

Have the students form arrays of their own choice and describe it to other class members.

Ask the students to create word problems to match the array they have constructed. For example, 4 bears live in each cave and there are 6 caves. How many bears altogether? Other students may then use their array paper to solve the problem.

After the student has formed an array, ask him or her to turn the array through ninety degrees and re-name the array.

Why?

Using arrays assist students to view rows of items as countable things, i.e. composite units. This strong visual representation of equal groupings will also help students to move beyond rhythmic counting and skip counting.



WR

Have the students record their solutions to the word problems using an empty number line for the skip counts. These could be used later to determine inverse operations.

Colour an array

Where are they now?

Students are able to form equal groups and find the total by counting by ones.

Where to next?

Students use skip counting to determine the total of the groups.



5 mm grid paper would be a suitable size for this activity.

Syllabus outcomes

NS2.3: Uses mental and informal written strategies for multiplication and division

PAS2.1: Generates, describes and records number patterns using a variety of strategies and completes simple number sentences by calculating missing values

WMS2.2: Selects and uses appropriate mental or written strategies, or technology, to solve problems

CMIT reference

Building multiplication and division through equal grouping: level 2

How?

Provide the students with grid paper and two dice. Tell the students that one die will represent the number of rows and the other die will represent the number of columns. Have each student roll the two dice and then colour in the corresponding number of squares on the grid paper to form an array. The student then cuts and pastes the arrays onto paper and records the number of columns, the number of rows and the total number of squares. Discuss strategies for determining the total. Students may record the information as a number sentence. Allow the students to share and compare their finished work.

Why?

Using arrays assist students to view rows of items as countable things, i.e. composite units. This strong visual representation of equal groupings will also help students to move beyond rhythmic counting and skip counting.

Self-correcting arrays

Where are they now?

Students are able to form equal groups and find the total by counting by ones.

Where to next?

Students use skip counting to determine the total of the groups.

Syllabus outcomes

NS2.3: Uses mental and informal written strategies for multiplication and division

PAS2.1: Generates, describes and records number patterns using a variety of strategies and completes simple number sentences by calculating missing values

WMS2.2: Selects and uses appropriate mental or written strategies, or technology, to solve problems

CMIT reference

Building multiplication and division through equal grouping: level 2

BLM

Self-correcting array, page 159

10 x 4 array, page 160

How?

Prepare an array and numeral sheet for the multiple to be practised and a cover board. A sheet for a 10×4 array is included in the BLM section. Display the covered array to the class. Reveal the top row of the array, ensuring the “tab” covers the end number. Ask questions such as: *How many dots in this row? How many rows can you see? How many dots altogether?* Progressively reveal the next row of dots and repeat questions. Encourage students to discuss how they are determining the total. If the students are counting by ones, encourage them to use skip counting. Allow the students to work in pairs and repeat the activity. The folded tab may be lifted after the students have answered, in order to check if they are correct.

Variation

Demonstrate how to determine division facts using the array structure.

Why?

Using arrays assist students to view rows of items as countable things, i.e. composite units. This strong visual representation of equal groupings will also help students to move beyond rhythmic counting and skip counting.

WR

Have the students use the multiplication questions to determine and record division facts.

Traffic tally

Where are they now?

Students find the total sum of groups by counting by ones.

Where to next?

Students find the total sum of groups by counting in multiples.



The common method of tallying involves making four vertical strokes and bundling these with a cross stroke for the fifth. 

Syllabus outcomes

DS2.1: Gathers and organises data, displays data using tables and graphs, and interprets the results

WMS2.3: Uses appropriate terminology to describe, and symbols to represent, mathematical ideas

CMIT reference

Building addition and subtraction through grouping: quinary-based strategies

Multiplication and division: level 3

How?

The students will need to be provided with a clipboard, paper and pen and will need to be in a location whereby they are able to observe passing traffic. Prior to the activity, ensure students understand the common method of tallying. In groups, students use tally marks to record the number of cars that pass by before a nominated vehicle passes. Each group could monitor the traffic for a different vehicle, for example, bus, motor bike, truck, petrol tanker or bicycle.

Variations

The nominated vehicle could be a particular coloured car or make of car.

Add “P” plate drivers, “L” plate drivers and pedestrians to the list.

Tally all vehicles that pass within a given time, for example 15 minutes and create a simple table to organise the data.

Transfer the information to a column graph or use *Compute-a-graph*.

Why?

This activity encourages students to use five as a sub-base by counting in fives. This has the potential to reduce the reliance on counting by ones.

High rollers 1

Where are they now?

Students find the total sum of groups by counting by ones.

Where to next?

Students find the total sum of groups by counting in multiples.

Syllabus outcomes

DS2.1: Gathers and organises data, displays data using tables and graphs, and interprets the results

WMS2.3: Uses appropriate terminology to describe, and symbols to represent, mathematical ideas

CMIT reference

Building addition and subtraction through grouping: quinary-based strategies

Multiplication and division: level 3

How?

Organise the students into groups and provide each group with a die. Each student in the group takes a turn to roll the die. The group records the number of times each number is rolled using tally marks. Continue until the die has been rolled a nominated number of times. Encourage the students to count by fives and then count on any additional single marks to determine the total. Have each group compare their results.

Variation

See High rollers 2 in the following section; *Forming groups*.

Why?

This activity encourages students to count by fives. This has the potential to reduce the reliance on counting by ones.

Four dice tally

Where are they now?

Students determine the sum total by counting by ones.

Where to next?

Use a variety of strategies to determine the sum total including combining numbers and counting multiples.

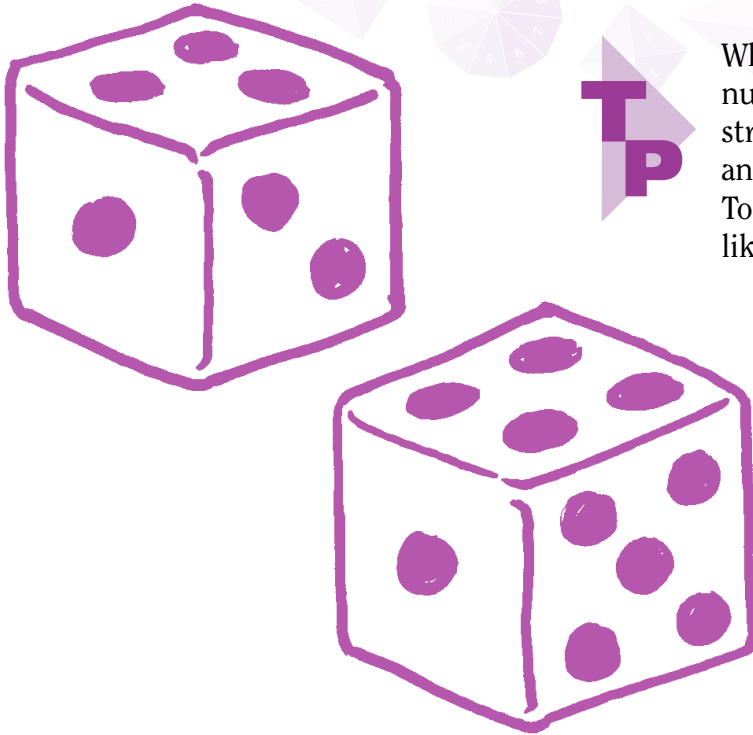

While the students are solving the number problems, observe the strategies they are using. Model and discuss efficient strategies. Totals between 4 and 14 are more likely than 15 to 24.

Syllabus outcomes

DS1.1: Gathers and organises data, displays data using column and picture graphs, and interprets the results

NS1.2: Uses a range of mental strategies and informal recording methods for addition and subtraction involving one- and two-digit numbers

WMS2.3: Uses appropriate terminology to describe, and symbols to represent, mathematical ideas

NS2.5: Describes and compares chance events in social and experimental contexts

CMIT reference

Building addition and subtraction through grouping: facile counting strategies

Combining and partitioning: To 20

BLM

Four dice tally, page 161

How?

Organise the students into groups and provide each group with four dice and a recording sheet. Instruct each student in the group to take turns to roll the four dice and to determine the total. The group records the answer on the recording sheet by marking a tally mark under the appropriate heading, 4–14 or 15–24. Have the groups compare their results. Combine the data from all of the groups on a single chart. Ask the students to indicate whether they believe it is more likely to score 4 to 14 than 15 to 24, about or less likely. Have them justify their answers.

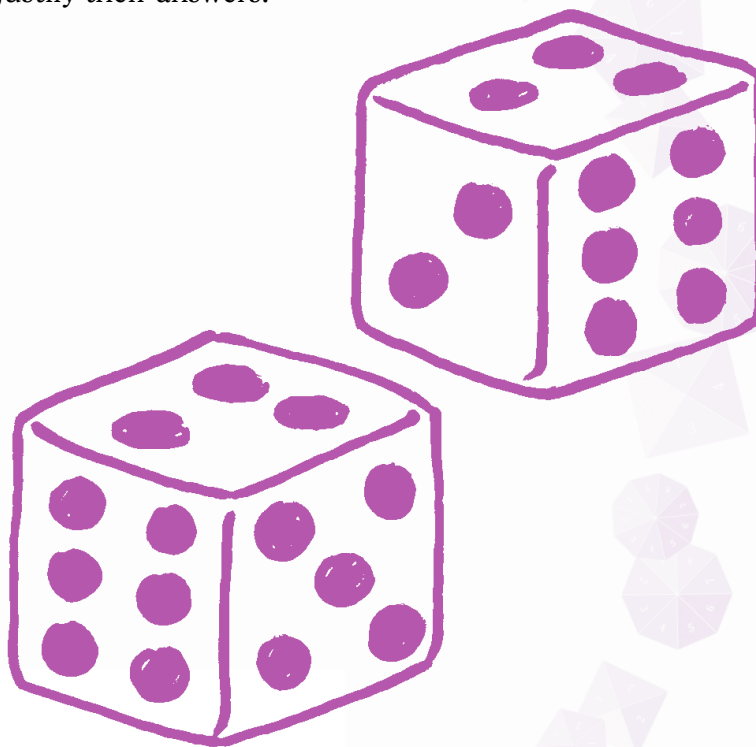

Why?

To become effective users of mathematics, students need to develop and use a variety of strategies other than counting by ones to solve problems.

Knotty problems

Where are they now?

Students determine the sum total by counting by ones.

Where to next?

Use a variety of strategies to determine the sum total including combining numbers and counting multiples.



Lengths of knitting could be saved and used for the *Woolly designs* activity on page 128.

Syllabus outcomes

DS2.1: Gathers and organises data, displays data using tables and graphs, and interprets the results

MS2.1: Estimates, measures, compares and records lengths, distances and perimeters in metres, centimetres and millimetres

WMS2.4: Checks the accuracy of a statement and explains the reasoning used

CMIT reference

Building multiplication and division through equal grouping: level 1 and 2

BLM

Knotty problems, page 162

How?

Teach the students to finger knit. Instructions are included on the *Knotty problems* BLM. Instruct the students to make a specific length of finger knitting. Have the students estimate the length rather than give them measuring devices. For example, ask the students to knit the wool to a length they think is 35 cm long. When they have finished knitting, ask the students to measure and record the amount they actually knitted to the nearest centimetre. Record the class results on a tally graph indicating the number of lengths that were knitted in the ranges, 34 to 36 cm, 30 to 40 cm, 25 to 45 cm or “other lengths” (students may only put a mark under one category). Encourage the students to use counting strategies such as counting in multiples and counting on to find the total of each group. Ask the students to determine how many links make 5 cm.

Variation

Organise the students into groups. Provide the students with directions to commence finger knitting. Periodically, signal the students to stop knitting and call out a nominated length, which the students have to estimate and indicate on their length of finger knitting. For example, the student holds one end of the knitting in one hand and firmly grasps a point along the knitting that he or she thinks is the nominated length. A group leader then measures and records each student’s estimated length of knitting. The teacher graphs the results on the chalkboard or overhead. Change group leaders each time a new estimation is called.

Why?

To become effective users of mathematics, students need to develop and use a variety of strategies other than counting by ones to solve problems.

Hoops and hats

Where are they now?

Students determine the sum total by counting by ones.

Where to next?

Use a variety of strategies to determine the sum total including combining numbers and counting multiples.



Syllabus outcomes

DS1.1: Gathers and organises data, displays data using column and picture graphs, and interprets the results

WMS2.3: Uses appropriate terminology to describe, and symbols to represent, mathematical ideas

CMIT reference

Building multiplication and division through equal grouping: level 1 and 2

How?

Draw a starting line on the ground. Place “witch hats” in a row at one metre, two metres and three metres away from the starting line. Have each student in the class attempt to throw a hoop over each of the hats. Repeat several times while using tally marks to record the number of hoops that are successfully thrown onto the hat at each distance. Encourage the students to use counting strategies such as counting in multiples to find the total of each group.

Why?

To become effective users of mathematics, students need to develop and use a variety of strategies other than counting by ones to solve problems.

Chain reaction

Where are they now?

Students need an adequate supply of units to measure the length of an object.

Where to next?

Students use one unit repeatedly to measure the length of an object.



Syllabus outcomes

MS1.1: Estimates, measures, compares and records lengths and distances using informal units, metres and centimetres

WM1.2: Uses objects, diagrams, imagery and technology to explore mathematical problems

CMIT reference

Count Me Into Measurement: Length 3.1

How?

Have the students construct a “ruler” by choosing an item and laying a nominated number of the items end-to-end on a paper strip. For example, a student may choose to make a “ruler” which is five paper clips long. Ensure the students line up the beginning of the unit with the edge of the strip. Instruct the students to mark their paper strip at the end of each unit and then cut it at the end of the last unit. Have the students measure and compare the length of various objects using their ruler. When recording the measurements, have the student record the length in terms of the number of units.

Why?

Students need to know how to precisely mark the end of each unit when measuring and that the lengths and not the marks or spaces are counted when measuring. Students also need to develop efficient counting strategies to assist them in measuring.

TP

Nylon packing tape would make an excellent substitute for the paper strip.

Streamer design

Where are they now?

Students need an adequate supply of units to measure the length of an object.

Where to next?

Students use one unit repeatedly to measure length.



Computational skills can be developed through measurement tasks. The students may use multiplication, addition and fraction concepts to solve this problem.

Syllabus outcomes

MS1.1: Estimates, measures, compares and records lengths and distances using informal units, metres and centimetres

NS2.3: Uses mental and informal written strategies for multiplication and division

WMS2.2: Selects and uses appropriate mental or written strategies, or technology, to solve problems

CMIT reference

Count Me Into Measurement: Length 3.1

Building multiplication and division through equal grouping: level 3

How?

Show rolls of coloured streamers to the students and tell them they are to create a design or picture for something to be made out of the streamers. Have the students draw their designs first. Tell the students that they are to determine the total length of streamer they will need to make their design. Provide them with a unit length of streamer, say 5 cm, to assist them to calculate the length. After, the students can measure and cut the streamer and paste onto their design.

Why?

Students need to know how to precisely mark the end of each unit when measuring and that the lengths and not the marks or spaces are counted when measuring. Students also need to develop efficient counting strategies to assist them in measuring.

WR

Students could initially record the number of units needed using tally marks.

 **Tile roller****Where are they now?**

Students use identical units to measure area, counting the total number of units by ones.

Where to next?

Students use the row structure repeatedly to measure area and count the total number of units by counting in multiples.

Syllabus outcomes

MS1.2: Estimates, measures, compares and records areas using informal units

PAS2.1: Generates, describes and records number patterns using a variety of strategies and completes simple number sentences by calculating missing values

WMS2.4: Checks the accuracy of a statement and explains the reasoning used

CMIT reference

Count Me Into Measurement: Area 2.1, 3.1

Building multiplication and division through equal grouping: level 2, 3

How?

Provide the students with a supply of tiles and a die. Students roll the die and collect the corresponding number of tiles to form a row. The student then rolls the die a second time to indicate the number of rows to repeat. The student determines and records the total number of tiles needed. Encourage the student to count in multiples. Have the student verify by either making the array with the tiles or drawing the pattern on grid paper and counting.

Why?

Students should be able to use a repeated row structure as a means of measuring area. Students also need to develop efficient counting strategies to assist them in measuring.

▶ Using nets 1

Where are they now?

Students use identical units to measure area, counting the total number of units by ones.

Where to next?

Students use the row structure repeatedly to measure area and count the total number of units by counting in multiples.



Depending on the size of the carton, 2 cm grid paper may be useful as each column is ten units.

Syllabus outcomes

MS1.2: Estimates, measures, compares and records areas using informal units

PAS2.1: Generates, describes and records number patterns using a variety of strategies and completes simple number sentences by calculating missing values

WMS2.2: selects and uses appropriate mental or written strategies, or technology, to solve problems

CMIT reference

Count Me Into Measurement: Area 3.1

Building multiplication and division through equal grouping: level 3

BLM

Using nets 1, page 163

How?

Provide the students with a selection of packages that they can open to form a net. Each student will also need a paper strip, cut from a row of grid paper. Have the students place the paper strip horizontally at the top of the net, draw a line under the strip and repeat the process down the cardboard. The individual units on the strip can be used to measure and draw areas outside the rectangle by the repeated use of the paper strip. Have the student use counting in multiples to determine the number of units needed to cover the rectangle and count on any additional units.

Why?

Students need to move and align units in a systematic way when measuring. Students also need to develop efficient counting strategies to assist them in measuring.

▶ Geoboard triangles 1

Where are they now?

The student recognises shapes in different orientations and proportions and checks by physical manipulation of materials.

Where to next?

The student is able to generate a variety of static visual images of a shape in different orientations.



Encourage students to create triangles other than equilateral triangles positioned on their base. Students need to pay attention to the relative location of the parts, such as sides, when rotating a triangle.

Syllabus outcomes

SGS2.2a: Manipulates, compares, sketches and names two-dimensional shapes and describes their features

WMS2.1: Asks questions that could be explored using mathematics in relation to Stage 2 content

WMS2.4: Checks the accuracy of a statement and explains the reasoning used

CMIT reference

Count Me Into Space: Orientation and motion: pattern and dynamic imagery strategies

How?

Organise the students into pairs and have one student create a triangle using a rubber band on a geoboard. The student should then draw the triangle on paper or cardboard and cut it out. This is used to aid directions. The student then tells his or her partner to make a second triangle on the geoboard that would result from the first triangle being moved by either flipping or turning. Allow the first student to match the instructions with his or her actions on the cutout triangle. Repeat the process and then swap roles.

Variation

Have the partner draw the triangle in the new orientation rather than making it on the geoboard.

Why?

Students need to explore shapes to help them move from restricted or fixed images of shapes to concept images that focus on properties that make up the shape.

Create a triangle

Where are they now?

The student recognises shapes in different orientations and proportions and check by physical manipulation of materials.

Where to next?

The student is able to generate a variety of static visual images of a shape in different orientations.

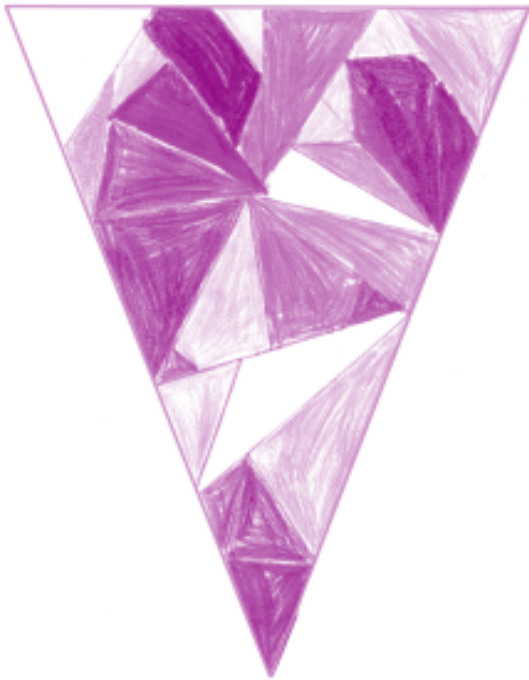

Show the students how a quadrilateral can be made into two triangles by drawing a line from one corner to another.

Syllabus outcomes

SGS2.2a: Manipulates, compares, sketches and names two-dimensional shapes and describes their features

WMS2.2: Selects and uses appropriate mental or written strategies, or technology, to solve problems

CMIT reference

Count Me Into Space: Part-whole relationships: pictorial imagery

BLM

Create a triangle, page 164

How?

Provide the students with a drawing of a large isosceles triangle. In pairs, students take turns to draw a line on the triangle to form more triangles. If a quadrilateral is formed the student must add another line to turn it into triangles. The drawing might be used as part of a visual arts lesson.

Variation

Have the students cut out each triangle, group them and explain how they have classified each group.

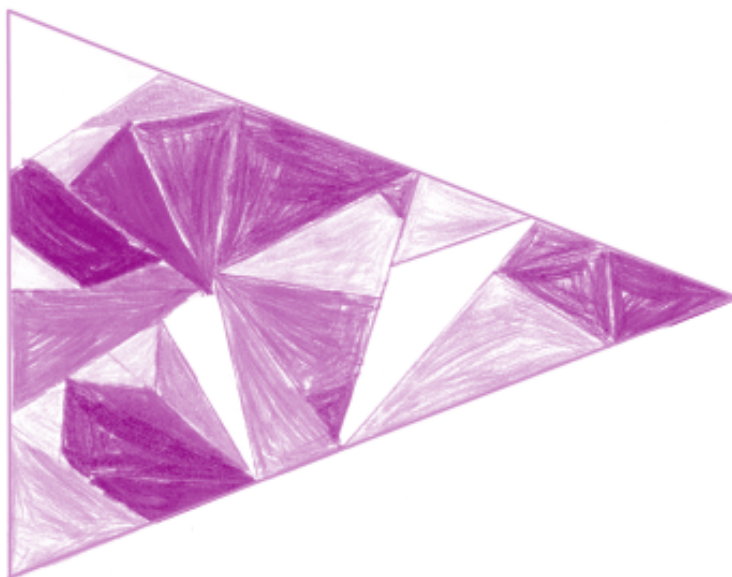

Why?

Students need to explore shapes to help them move from restricted or fixed images of shapes to concept images that focus on properties that make up the shape.

Symmetry pattern

Where are they now?

The student recognises shapes in different orientations and proportions and checks by physical manipulation of materials.

Where to next?

The student is able to generate a variety of static visual images of a shape in different orientations.

Syllabus outcomes

SGS2.2a: Manipulates, compares, sketches and names two-dimensional shapes and describes their features

CMIT reference

Count Me Into Space: Orientation and motion: pattern and dynamic imagery strategies

How?

Draw a line down the centre of a page and ask one student to draw a rectangle on one side of the line. One side of the rectangle should be part of the dividing line on the page. The student's partner then draws a rectangle that is the reflection of the first rectangle. The first student continues to add straight lines to the rectangle. The student's partner must then add the same line to their rectangle so that it shows a symmetrical result.

Variation

Use coloured building blocks to create a symmetrical model with a partner.

Why?

Students need to explore shapes to help them move from restricted or fixed images of shapes to concept images that focus on properties that make up the shape.

Walking the dog

Where are they now?

The student recognises shapes in different orientations and proportions and checks by physical manipulation of materials.

Where to next?

The student is able to generate a variety of static visual images of a shape in different orientations.



A initial line may need to be provided on the paper and instructions given as to where the rectangle is to finish.

Syllabus outcomes

SGS2.2a: Manipulates, compares, sketches and names two-dimensional shapes and describes their features

CMIT reference

Count Me Into Space: Orientation and motion: pattern and dynamic imagery strategies

How?

Provide each pair of students with a small cardboard rectangle and a piece of paper. The first student draws a line (say 5 cm long) on the paper. The second student places one side of the rectangle on the line and traces around the other three sides of the rectangle. The first student then draws another line along one edge of the rectangle. The second student must flip the rectangle over the new line and draw the rectangle in its new position. Continue the process until the rectangle finishes in a nominated location on the page, e.g. bottom right corner.

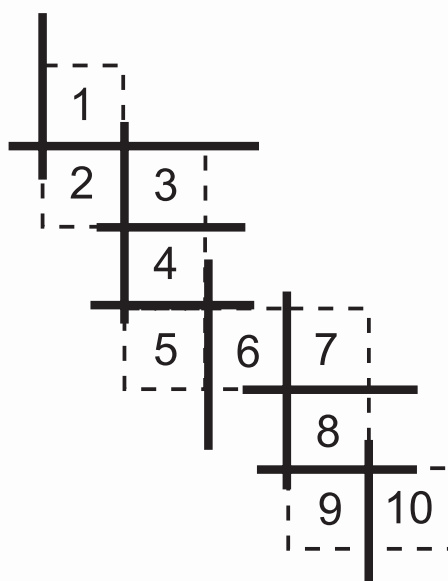

Why?

Students need to explore shapes to help them move from restricted or fixed images of shapes to concept images that focus on properties that make up the shape.

Woolly designs

Where are they now?

The student recognises shapes in different orientations and proportions and checks by physical manipulation of materials.

Where to next?

The student is able to generate a variety of static visual images of a shape in different orientations.

Syllabus outcomes

SGS2.2a: Manipulates, compares, sketches and names two-dimensional shapes and describes their features

WMS2.4: Checks the accuracy of a statement and explains the reasoning used

CMIT reference

Count Me Into Space: Orientation and motion: pattern and dynamic imagery strategies

BLM

Knotty problems, page 162

How?

Have the students make a length of finger knitting. (Students may already have made their finger knitting during a previous activity *Knotty problems* page 110. Instructions for finger knitting are included in the BLM section.) Instruct the students to fold a piece of paper in half and glue the wool onto one side. Discuss the types of lines that could be made with the wool. When dry, the students then draw the reflection of the design on the other side of the paper to create a symmetrical design. Have the students continue to add patterns and lines to continue the design, ensuring that it remains symmetrical.

Variation

Use some of the finger knitting, say a 20 cm length, to make a line design and glue the design onto a long strip of paper. Students then imagine the design has moved by flipping or turning and draw the design in its new orientation. Repeat the process and draw the result. Have the students explain their drawings.

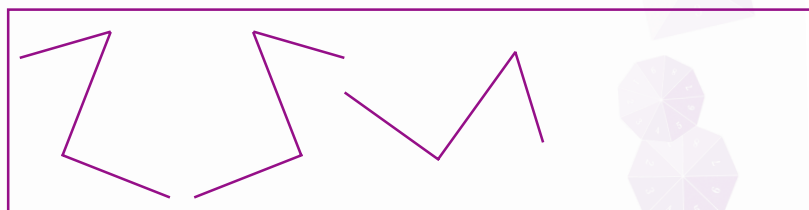

Why?

Students need to explore shapes to help them move from restricted or fixed images of shapes to concept images that focus on properties that make up the shape.

Recognising angles in shapes

Where are they now?

Students can recognise angles in shapes through physical manipulation.

Where to next?

Students are able to recognise more than one angle in shapes and describe these angles.



Instruct the students to trace each type of angle in a different colour.

Syllabus outcomes

SGS2.2b: Identifies, compares and describes angles in practical situations

WMS2.1: Asks questions that could be explored using mathematics in relation to Stage 2 content

WMS2.4: Checks the accuracy of a statement and explains the reasoning used

CMIT reference

Count Me Into Space: Part-whole relationships: pictorial imagery

BLM

Recognising angles in shapes, page 165

Recognising angles in shapes, page 166

How?

Prepare a worksheet for each student showing various 2-dimensional shapes and a set of cards displaying drawings of different angles. Place the angle cards in a pile face down. In turns, the students select a card from the pile and show it to the group. Each student in the group then demonstrates which shapes contain the same angle as the one on the card by tracing over the angles within the shapes on the worksheet. Have the students then compare their solutions. The students may check by placing the angle onto the shapes.

Variation

Prepare the angle cards on OHT acetate. The students could then place them on top of the worksheet to verify their solutions.

Use a set of pattern blocks instead of the shapes worksheet.

Why?

Students need to be able to identify and describe angles in a range of situations.

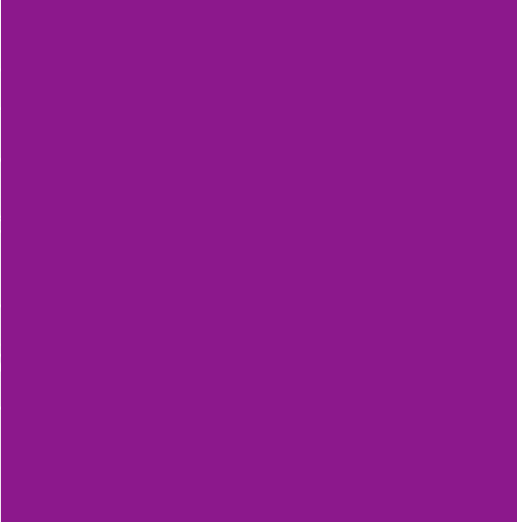

Counting by ones blackline masters

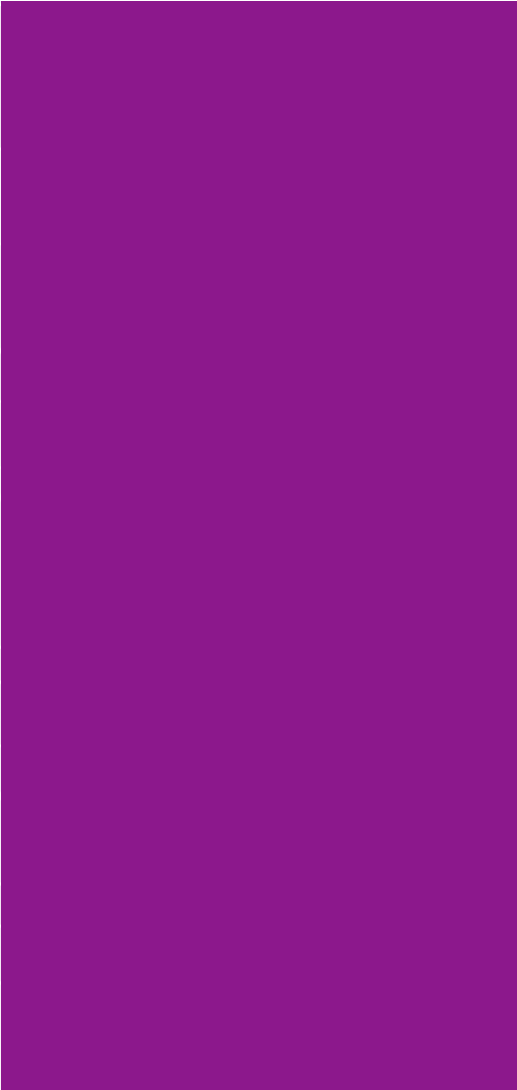

Domino adding pairs

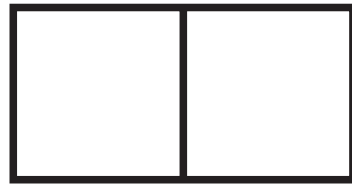
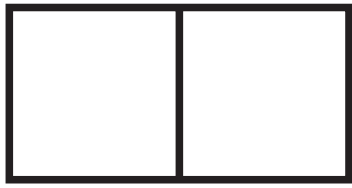

$$\underline{\quad} + \underline{\quad} = \underline{\quad}$$

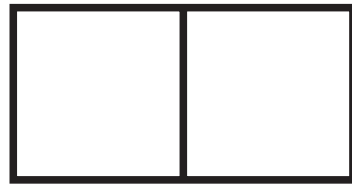
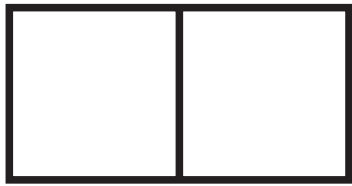

$$\underline{\quad} + \underline{\quad} = \underline{\quad}$$

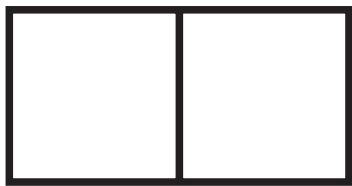

$$\underline{\quad} + \underline{\quad} = \underline{\quad}$$

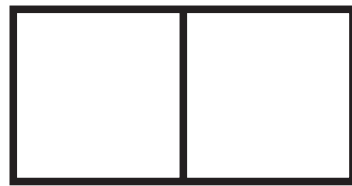
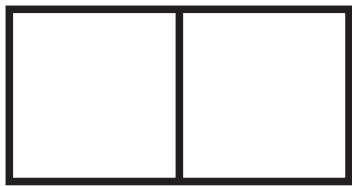

$$\underline{\quad} + \underline{\quad} = \underline{\quad}$$

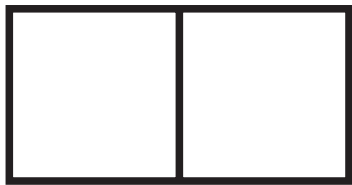

$$\underline{\quad} + \underline{\quad} = \underline{\quad}$$

Addition star

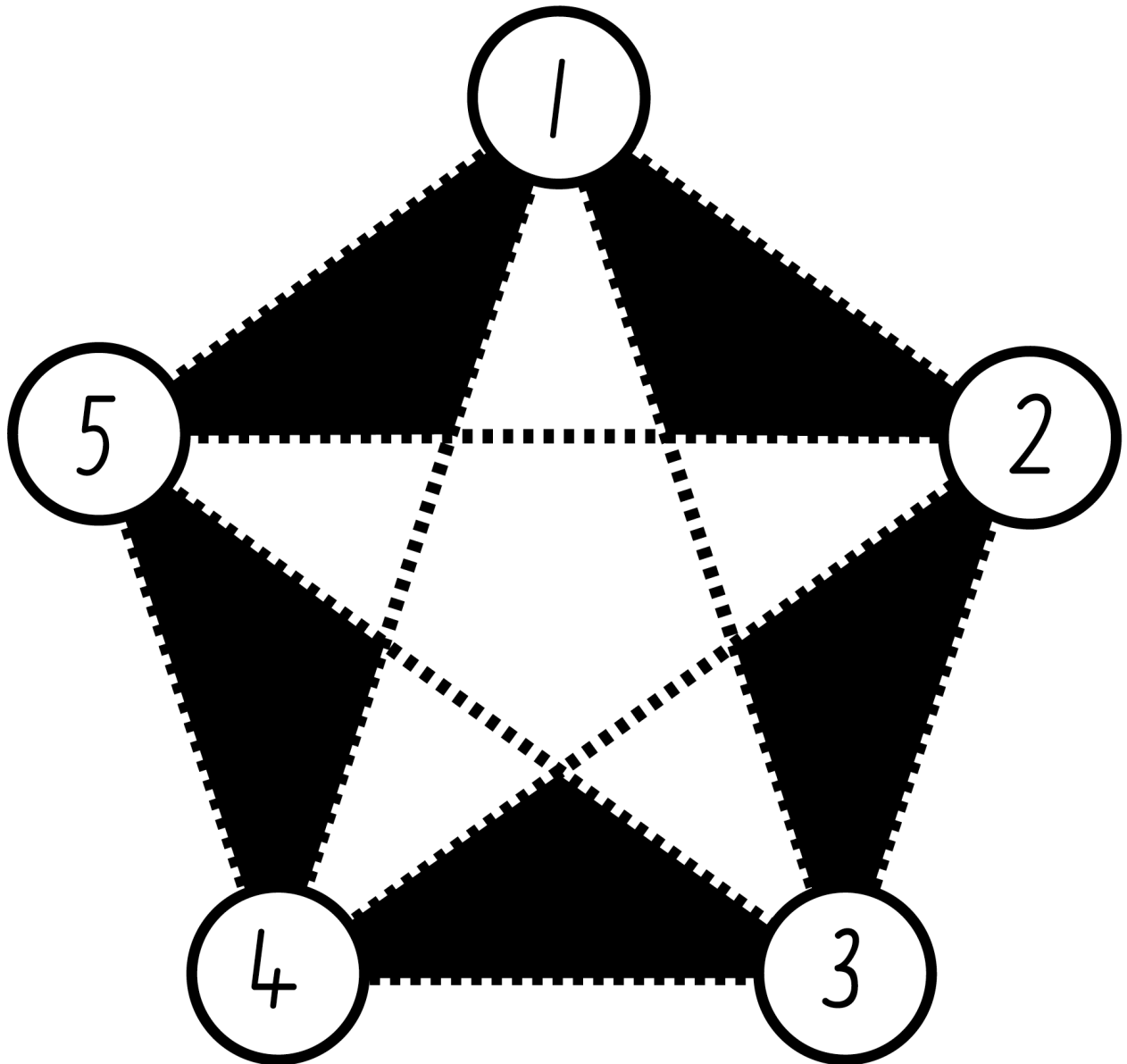

Brainy fish

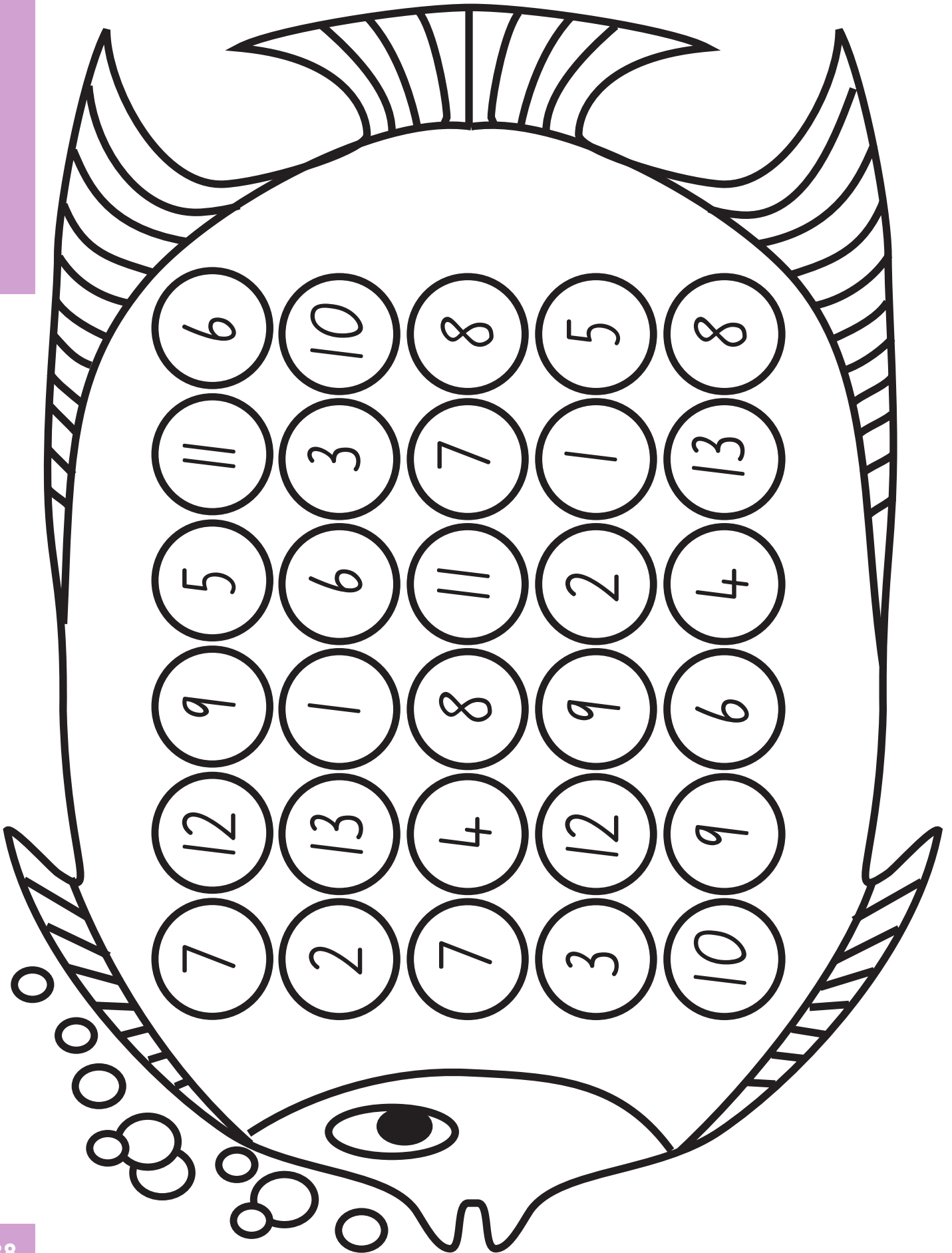

Brainy fish spinner

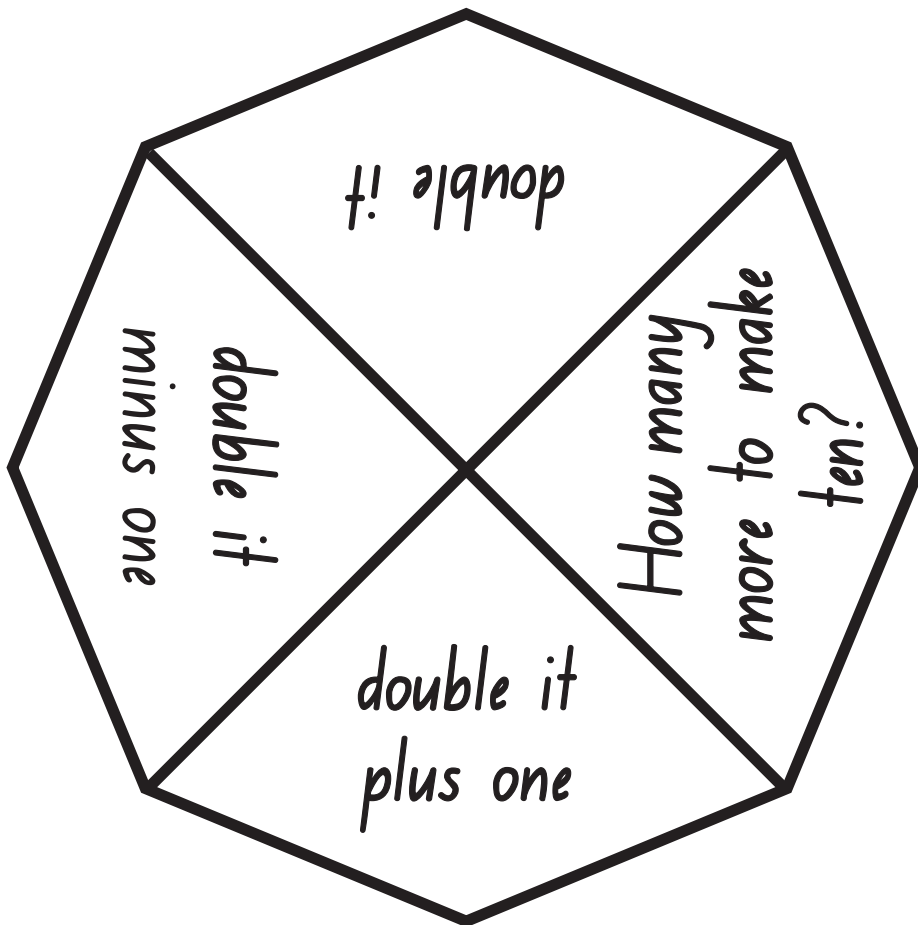

Addition wheel pairs

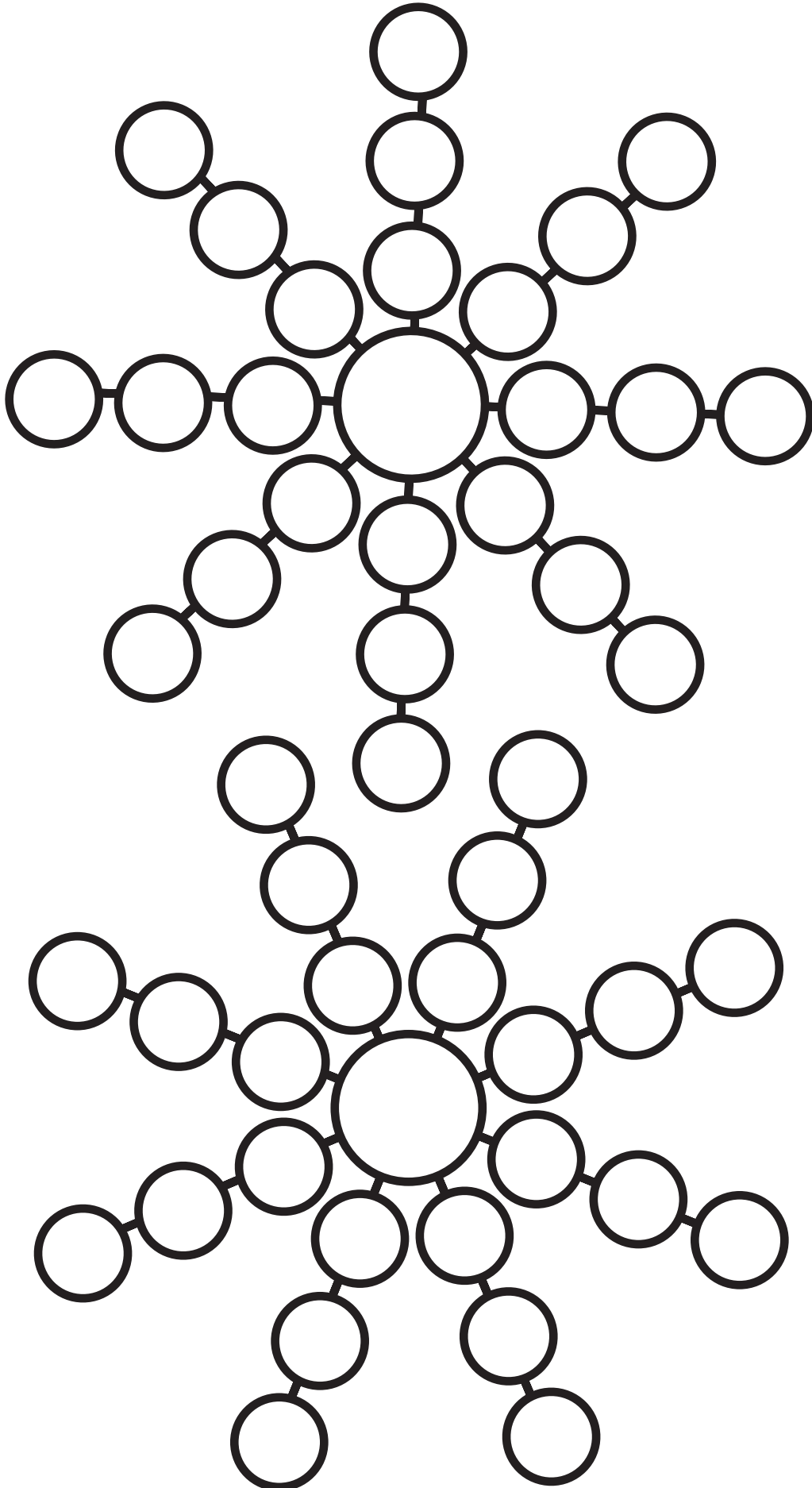

Counter play

4	3	8
9	5	1
2	7	6

Copy that

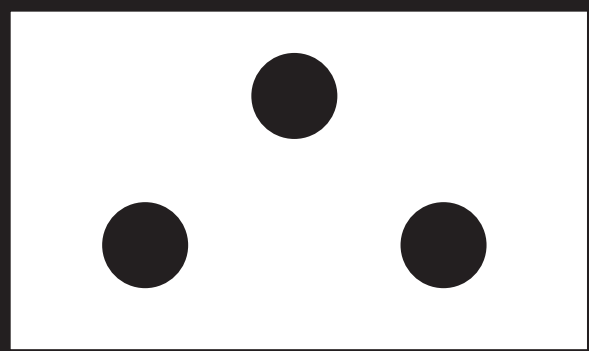
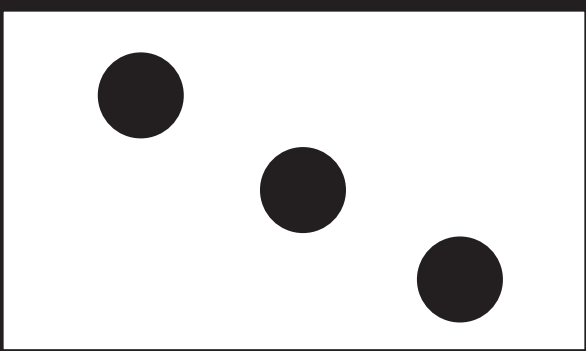
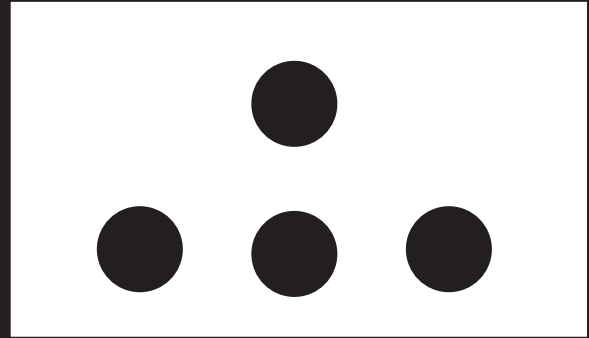
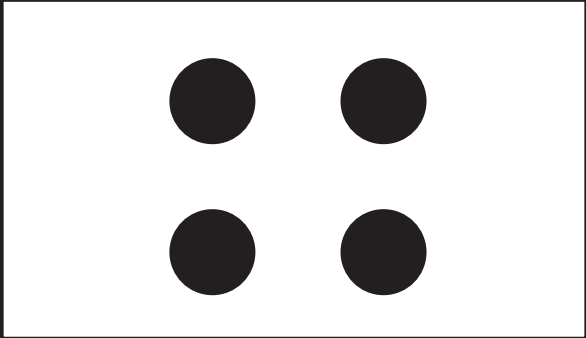
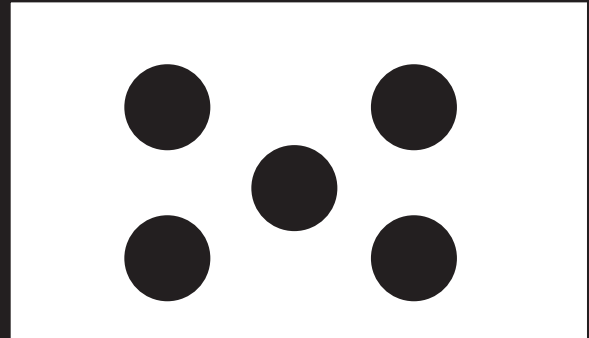
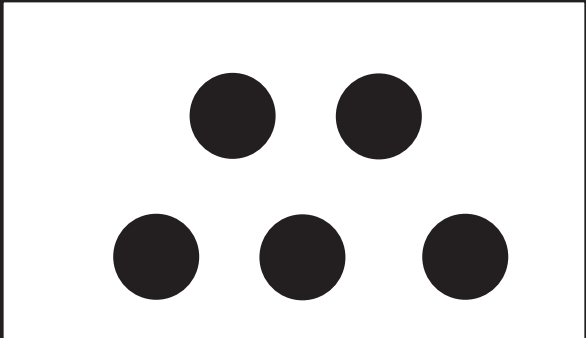
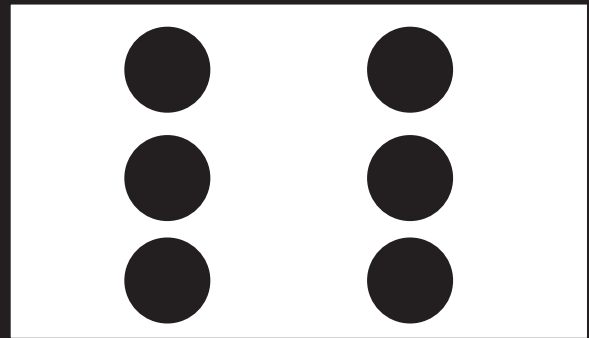
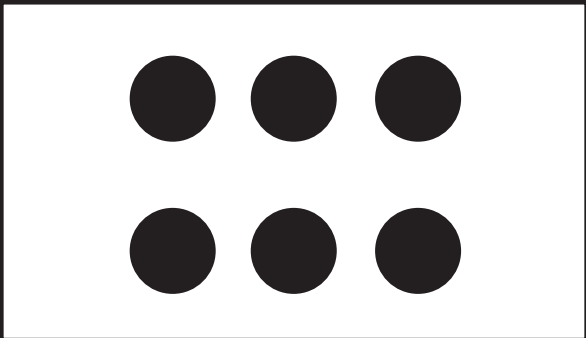
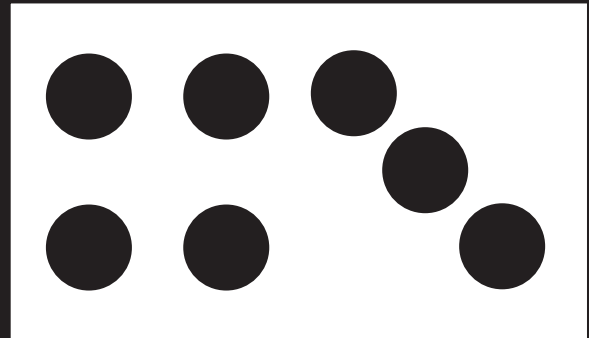
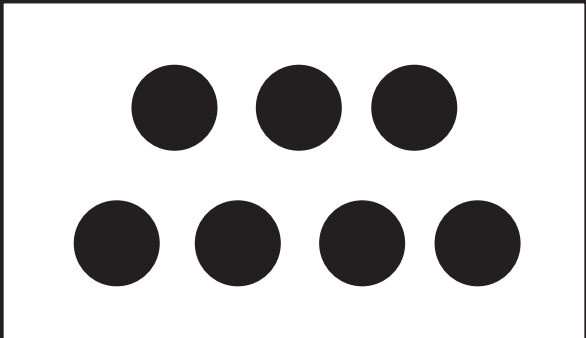
Bunches of five

Double scoops

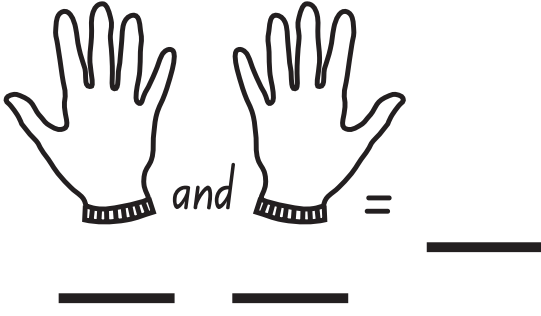
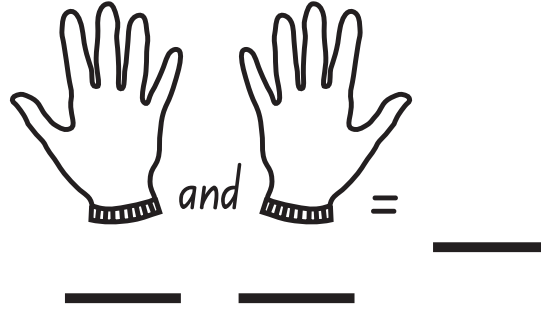
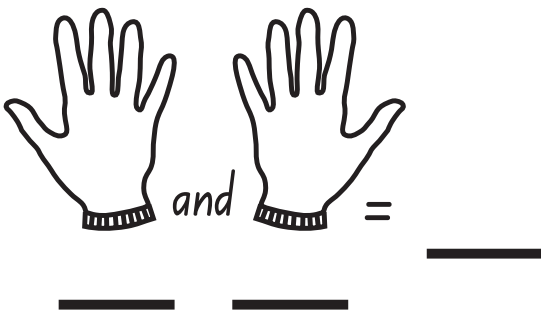
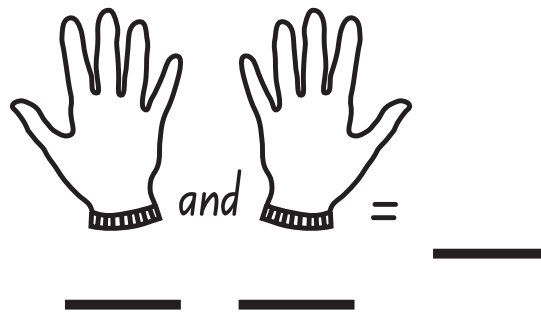
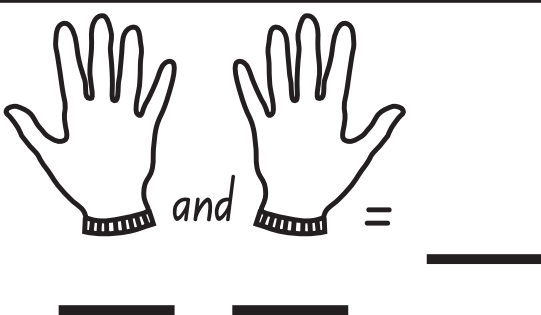
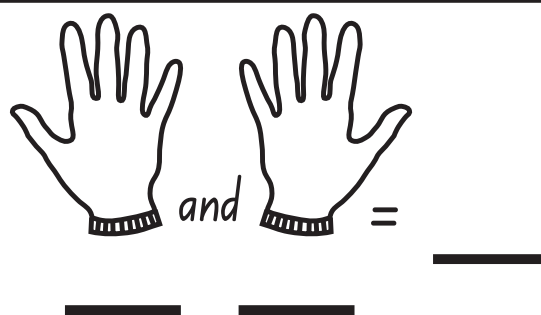
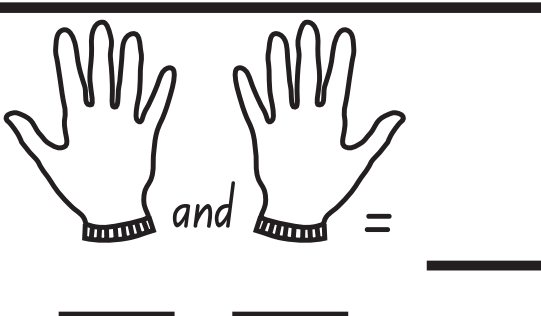
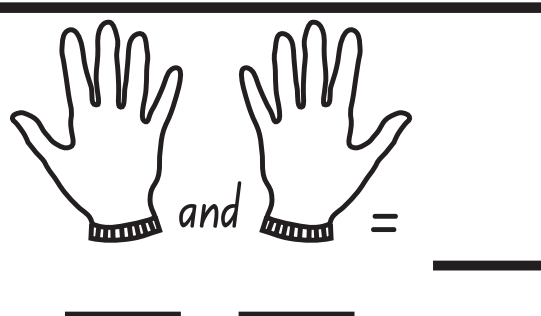
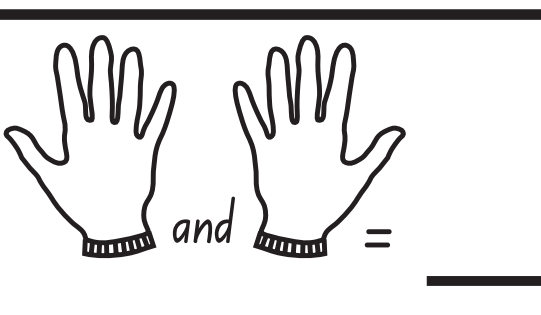
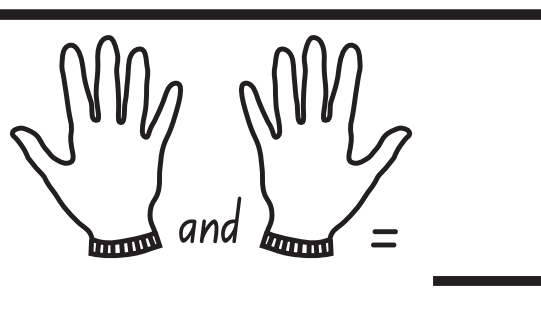

“Make ten” grids

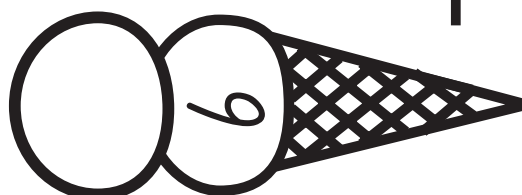
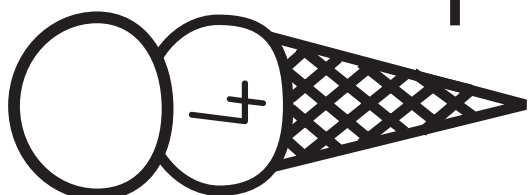
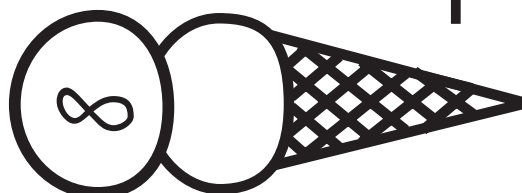
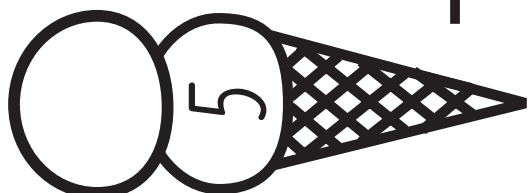
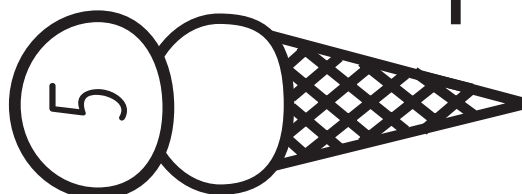
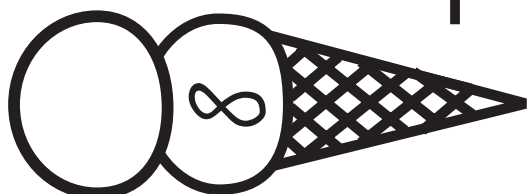
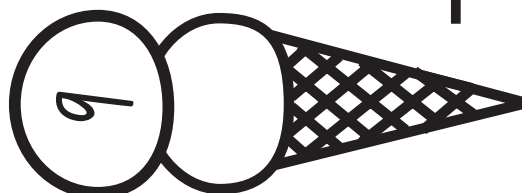
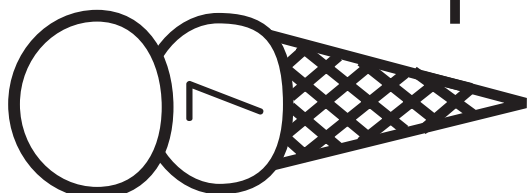
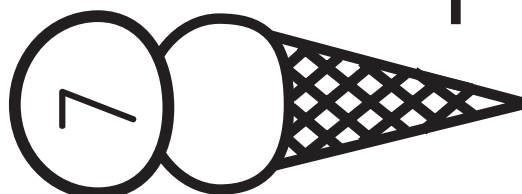
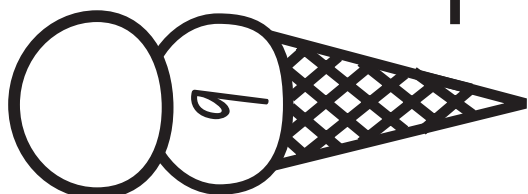
1	6	9	2	9
9	8	3	10	4
5	7	4	9	2
6	6	7	10	5
3	8	8	3	1

7	1	2	5	4
4	10	6	8	1
7	7	6	3	2
6	8	9	5	3
5	9	10	5	8

1	2	3	4	5
10	1	9	7	6
3	2	5	6	10
4	3	4	5	8
5	6	7	8	9

Number draughts

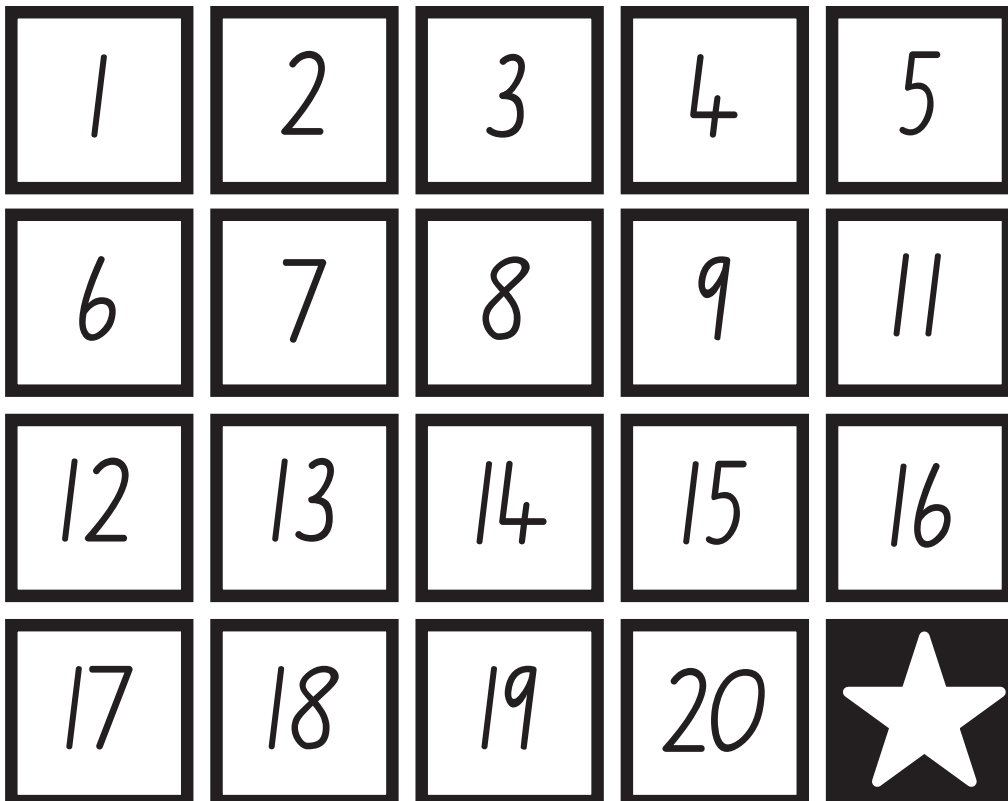
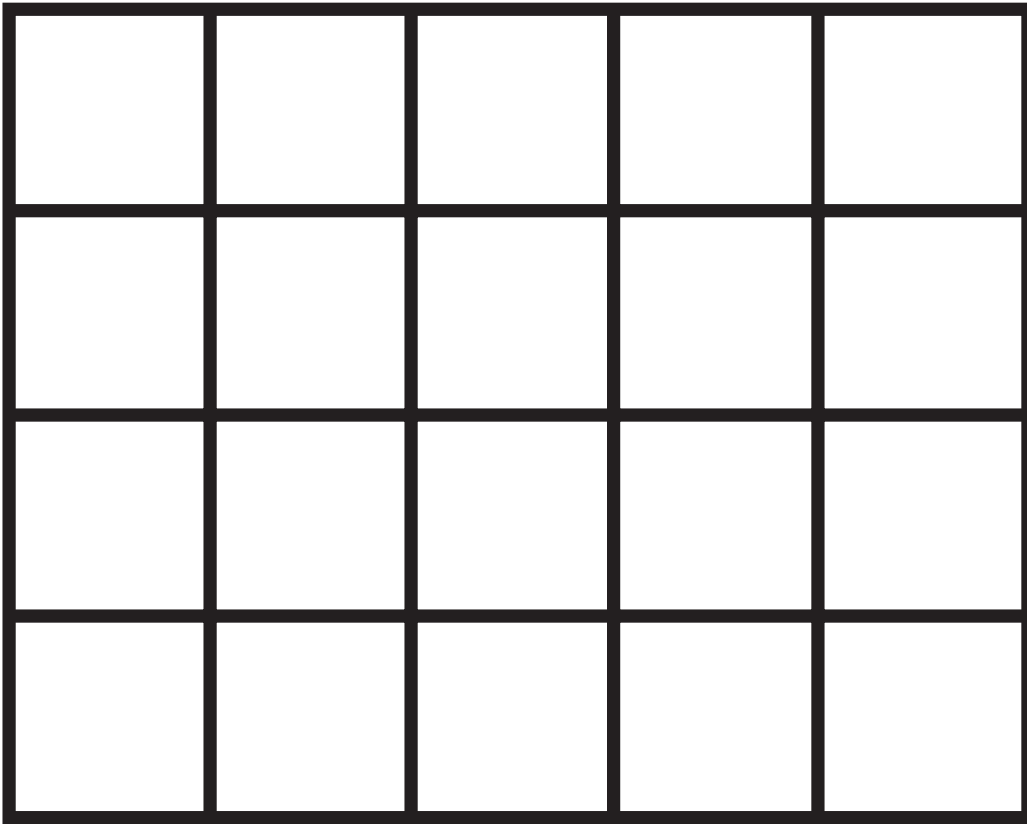

Dizzy dots

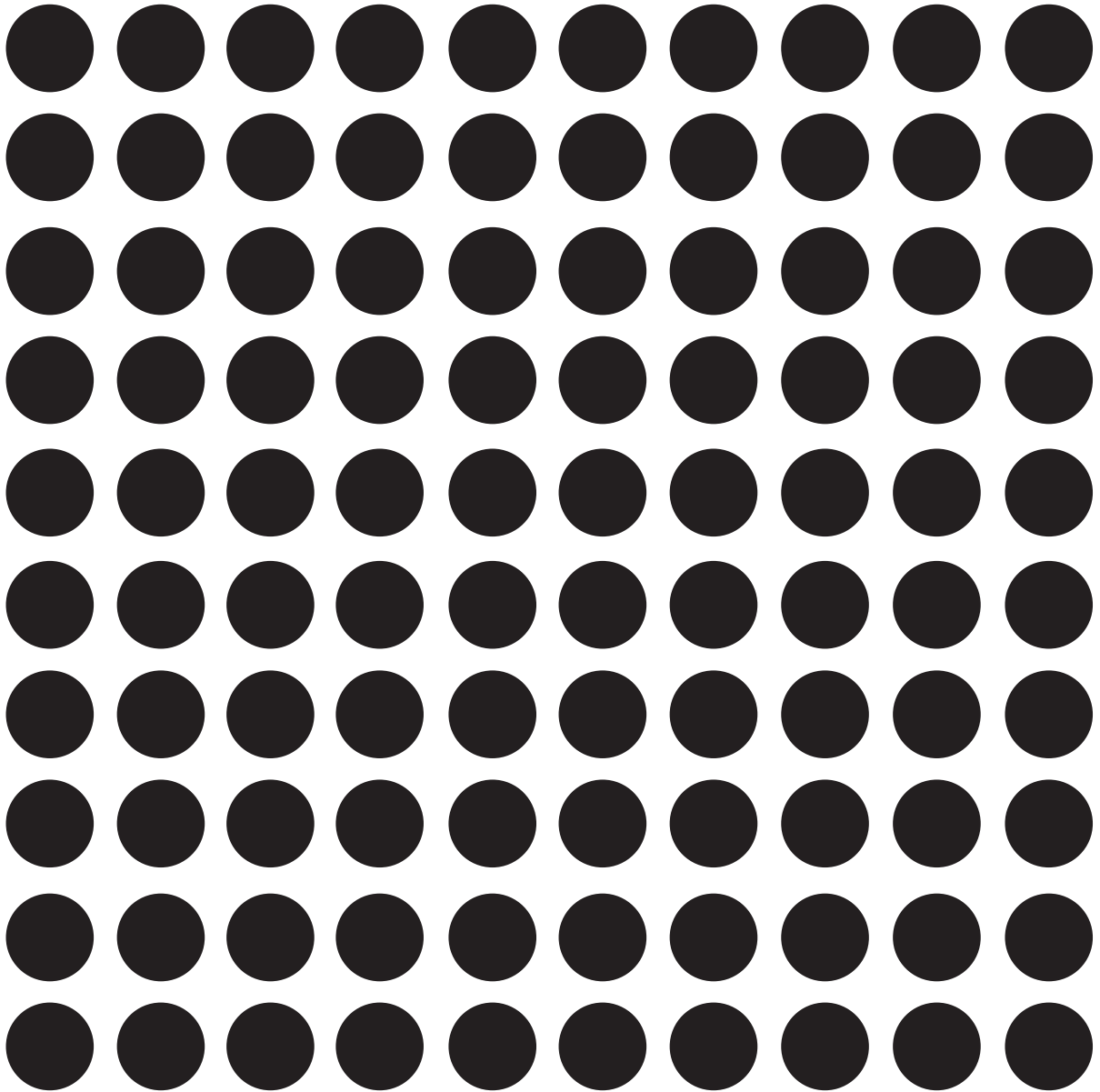

Ten-frame

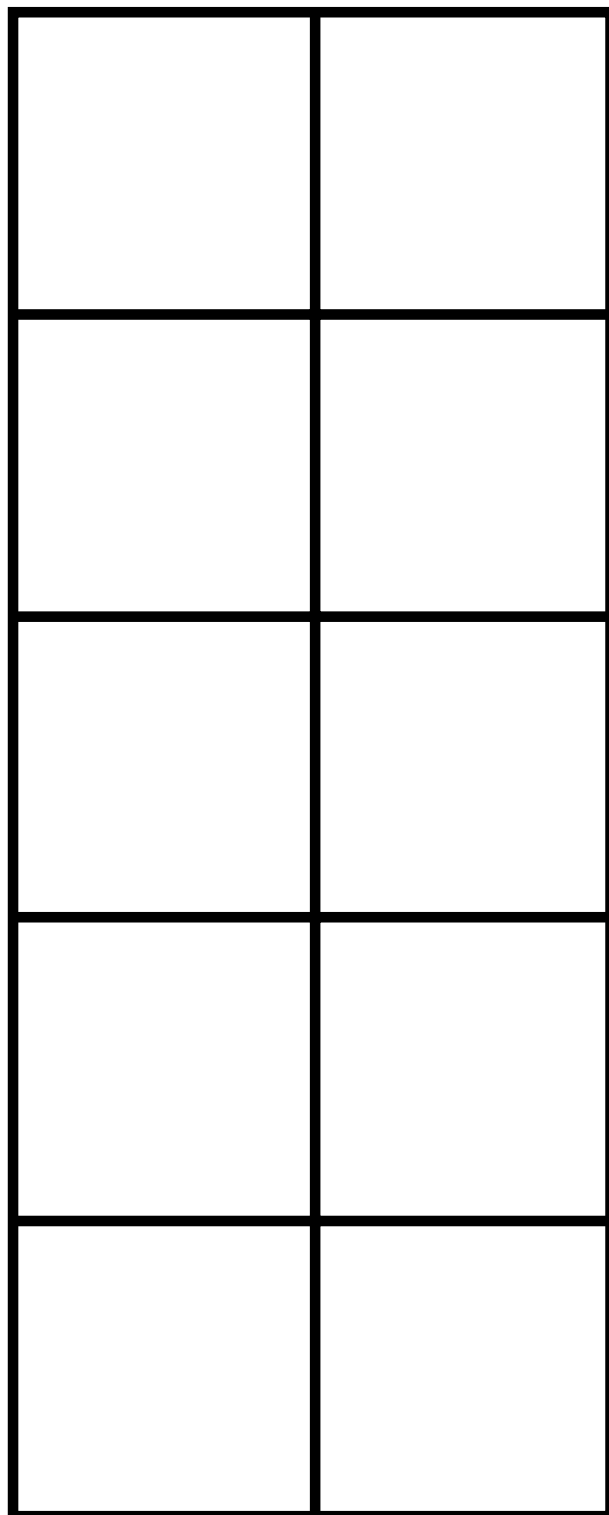

Hundred chart windows

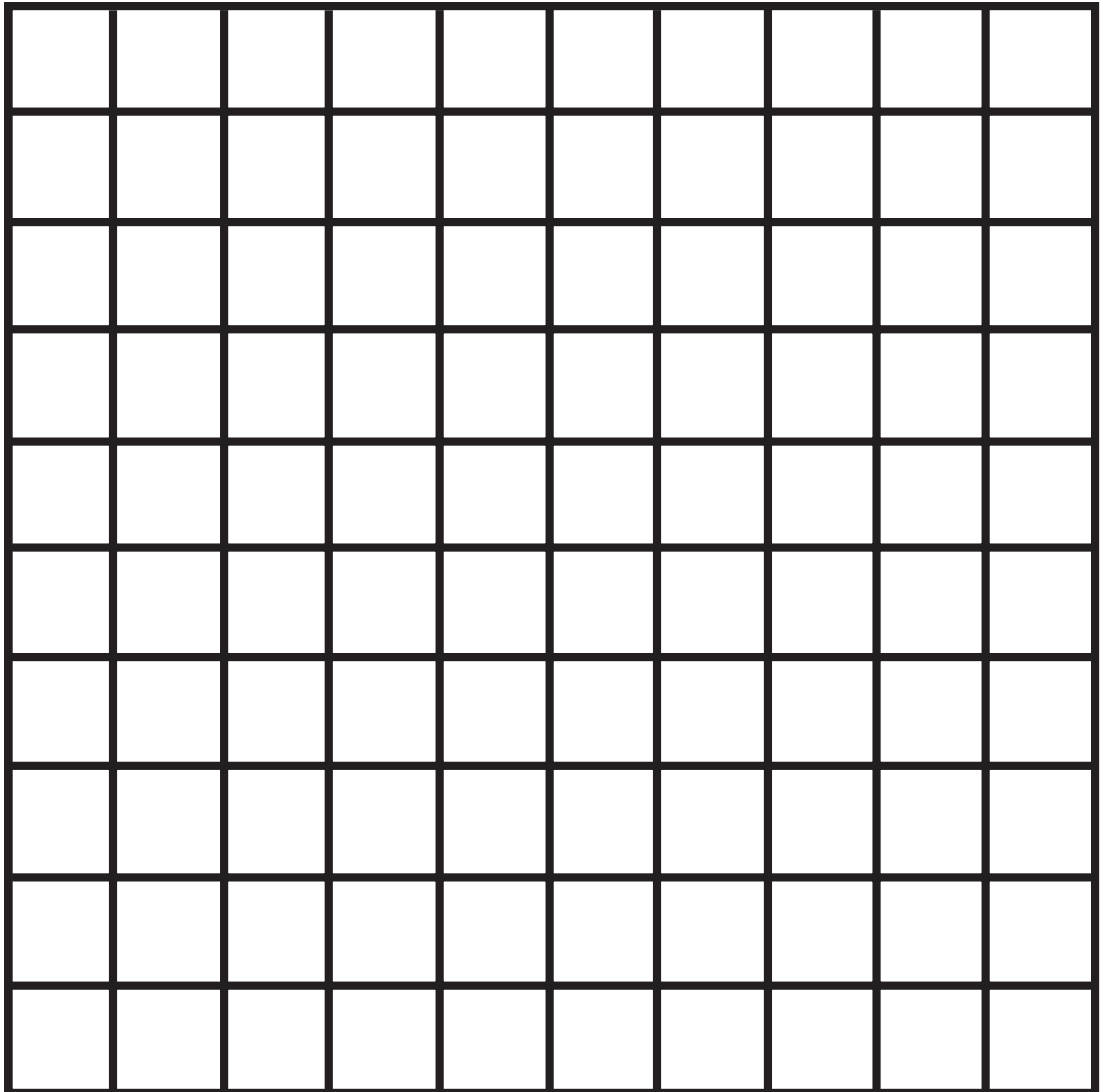

Hundred chart windows sample

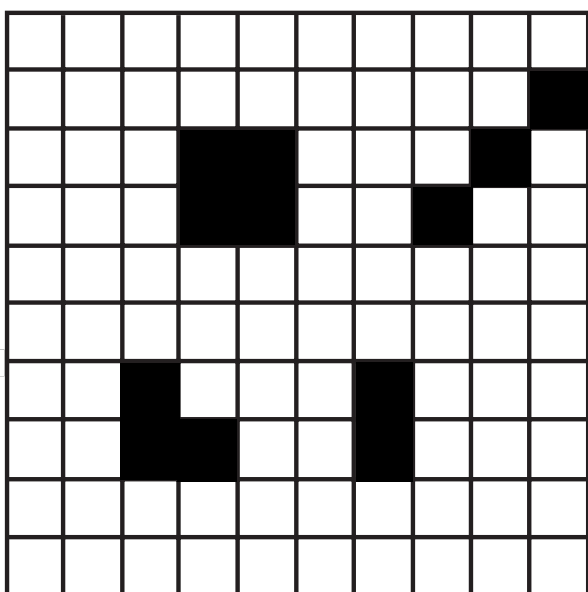

Using all three cards will reveal all numbers on the hundred chart.

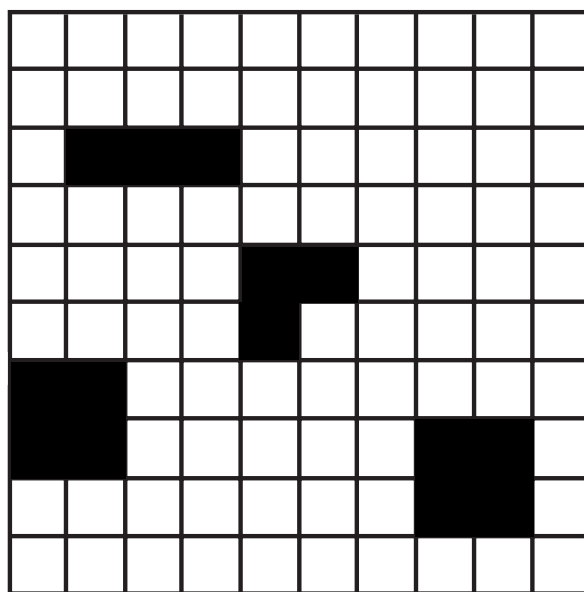

Cut out black areas on cards.

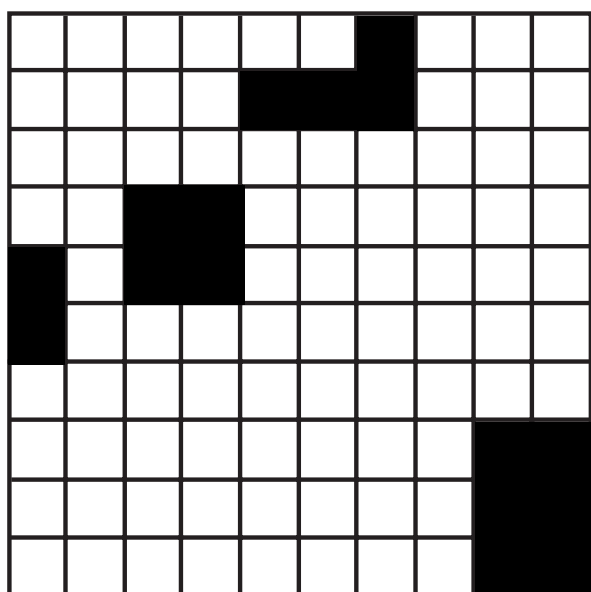

Eggsactly



Hundred chart

1	2	3	4	5	6	7	8	9	10
11	12	13	14	15	16	17	18	19	20
21	22	23	24	25	26	27	28	29	30
31	32	33	34	35	36	37	38	39	40
41	42	43	44	45	46	47	48	49	50
51	52	53	54	55	56	57	58	59	60
61	62	63	64	65	66	67	68	69	70
71	72	73	74	75	76	77	78	79	80
81	82	83	84	85	86	87	88	89	90
91	92	93	94	95	96	97	98	99	100

Cover-up strips

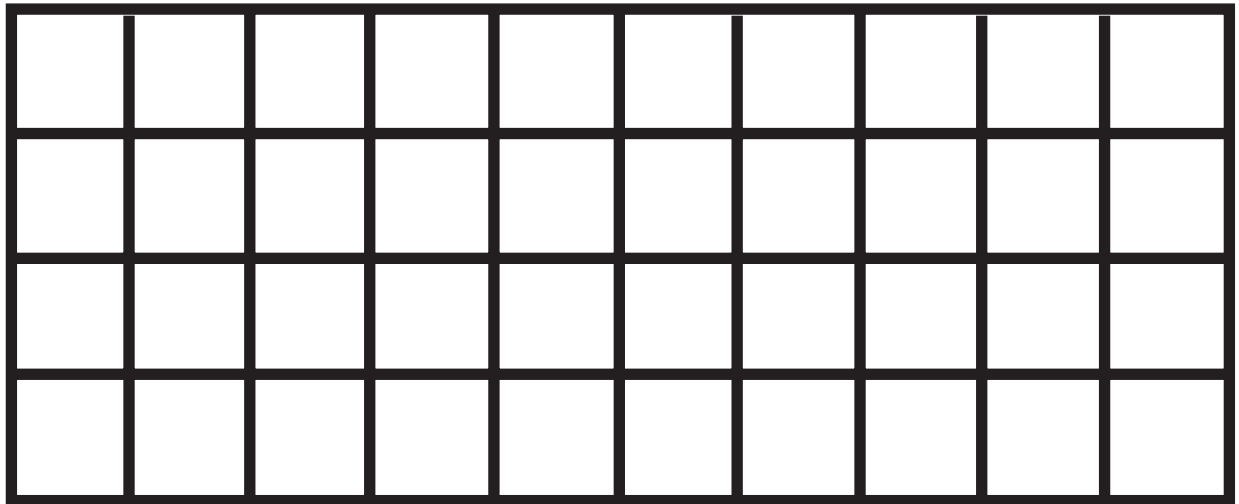
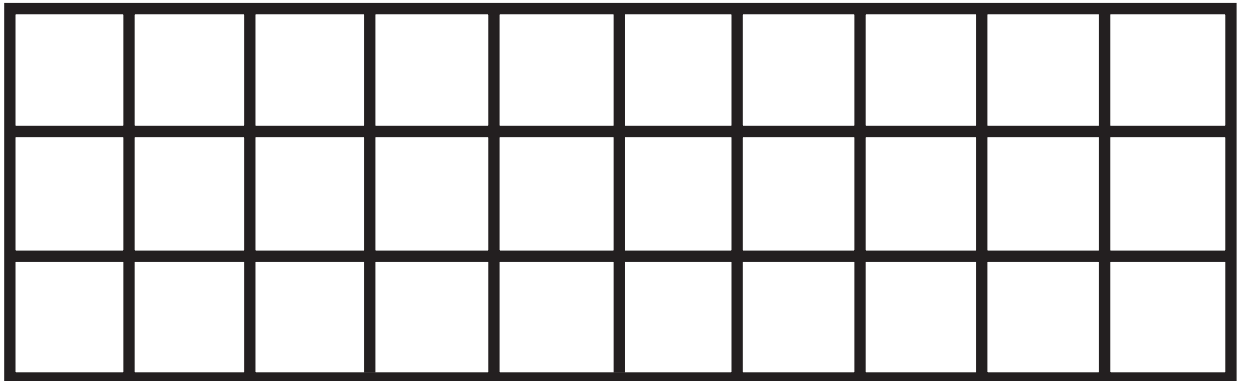
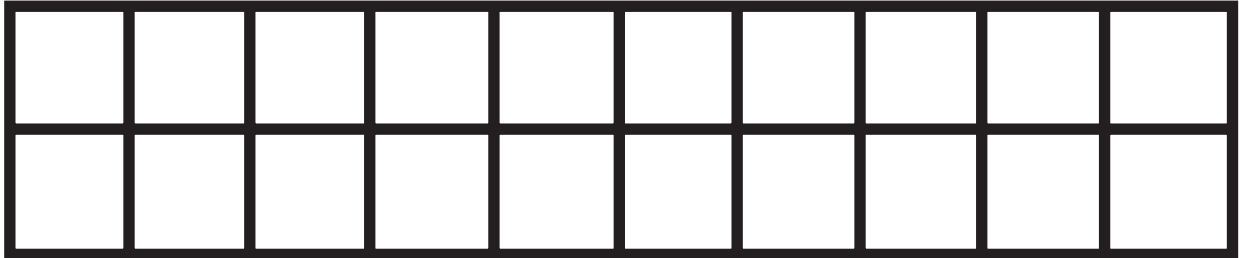

Tracks

Number

Arrows

Number

Number

Arrows

Number

Number

Arrows

Number

Number

Arrows

Number

Number

Arrows





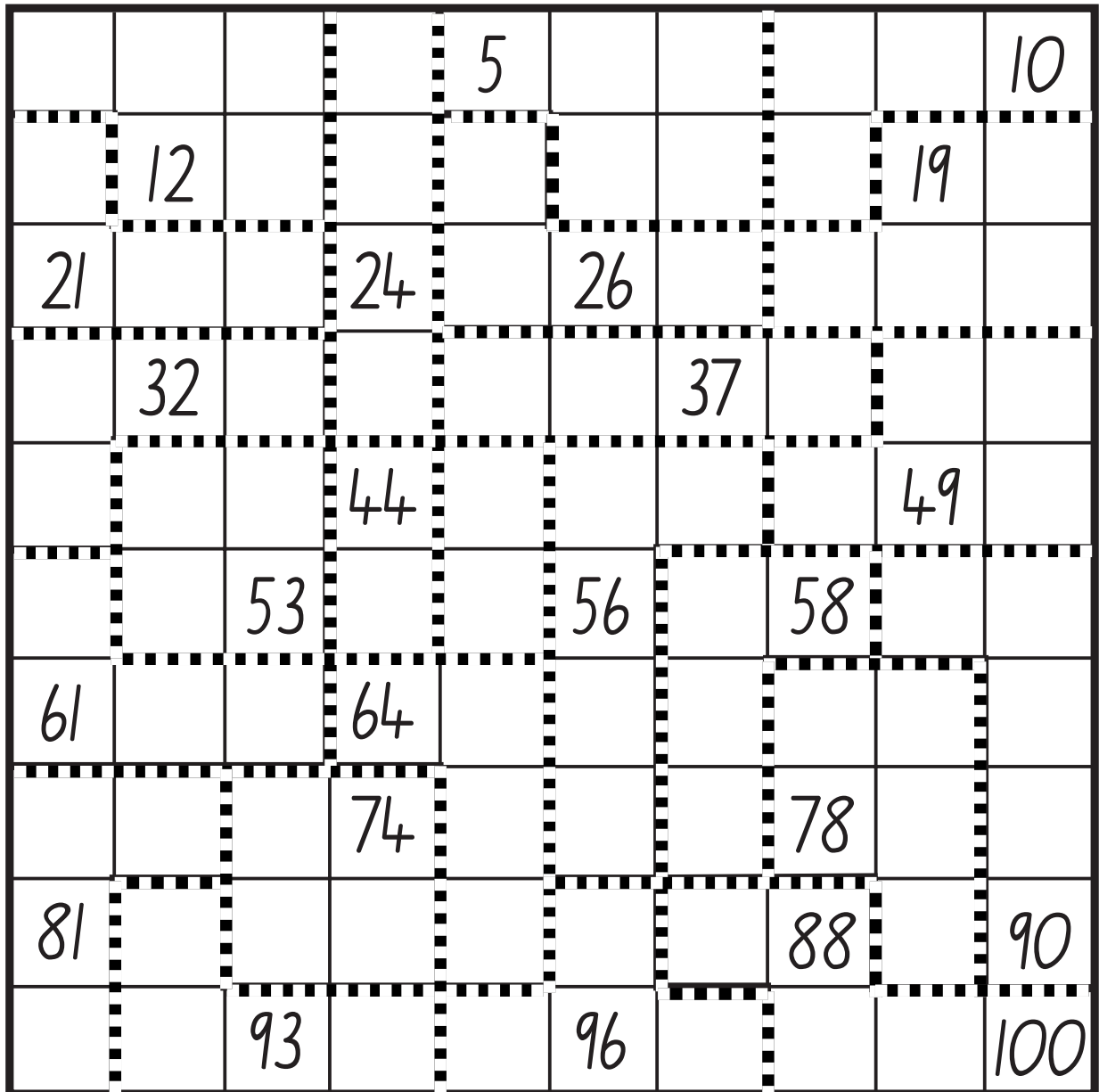

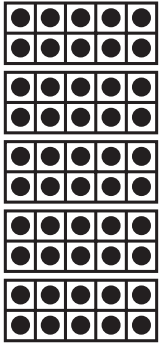
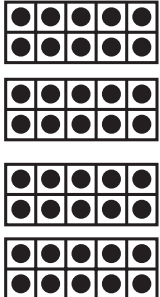
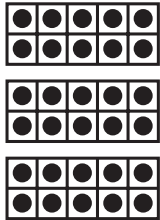
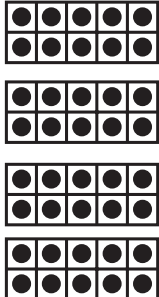
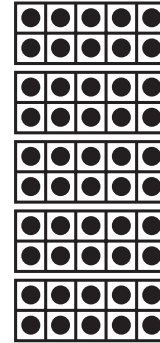
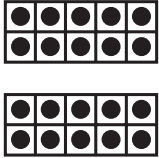
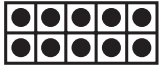
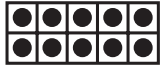
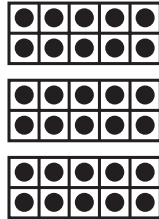
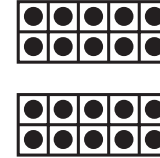
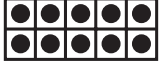

Number

Hundred chart jigsaw

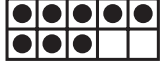

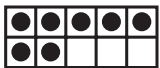
* Cut along broken lines

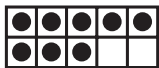
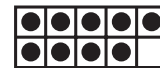
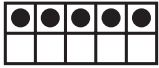
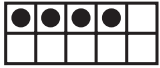
Teeny tiny ten-frames

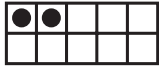
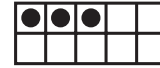
Teddy tummies

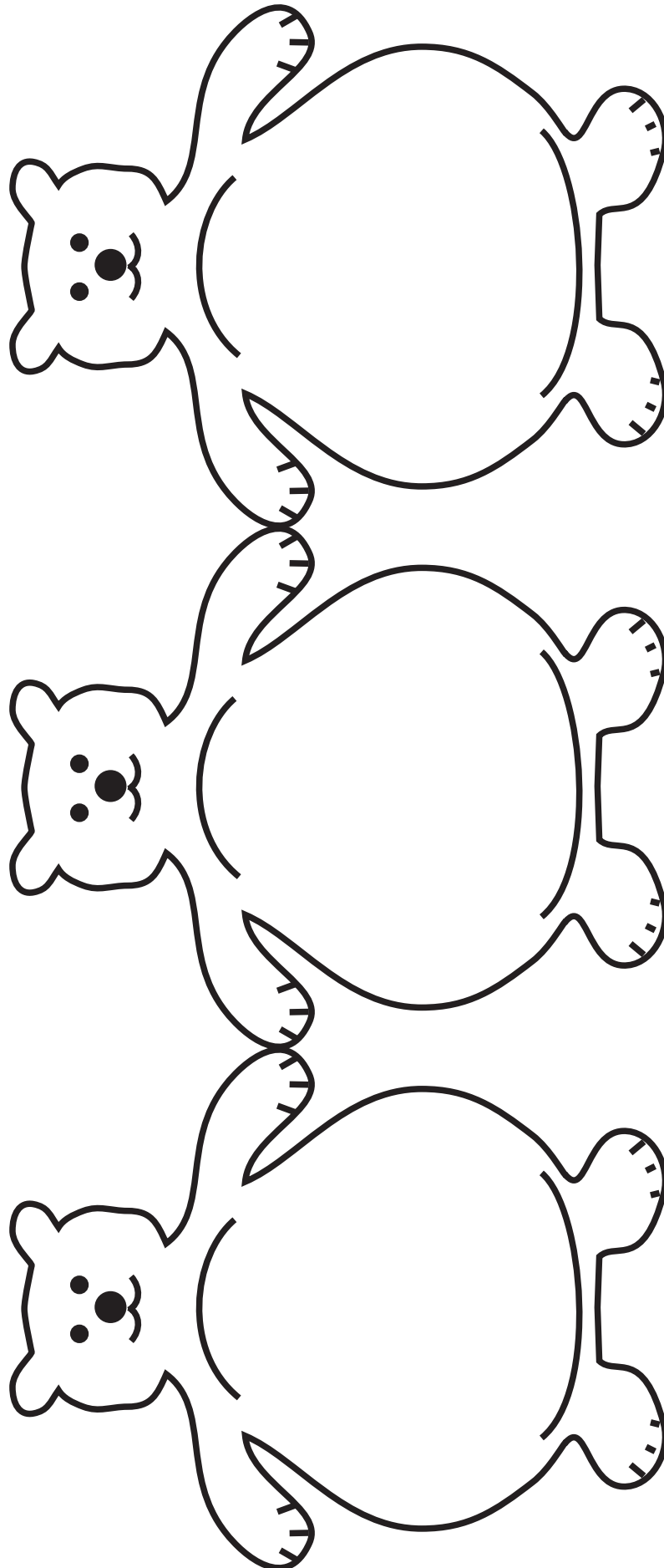

Counter grab







Estimate	How many groups of ___?	How many remainders?	Total
	___ groups of ___		
	___ groups of ___		
	___ groups of ___		
	___ groups of ___		
	___ groups of ___		
	___ groups of ___		
	___ groups of ___		

Self-correcting arrays

Cut out this black section and discard

fold

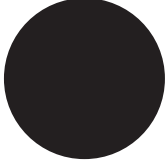
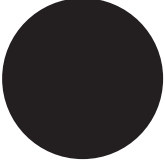
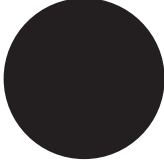

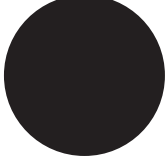
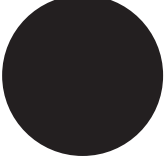
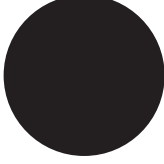
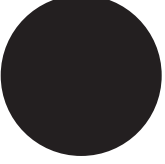
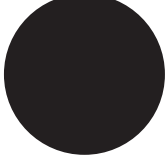
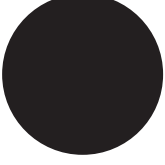
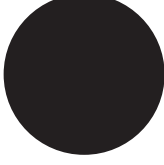
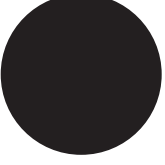
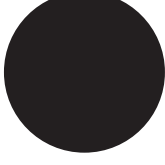
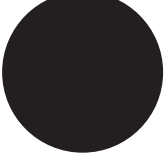
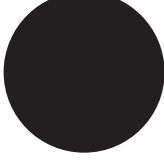
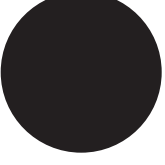
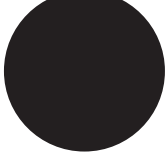
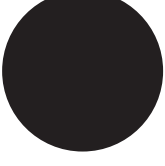
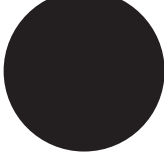
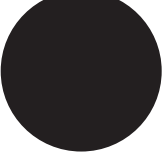
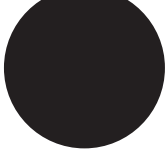
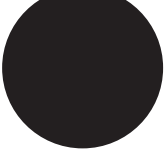
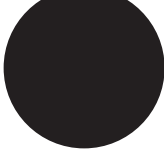
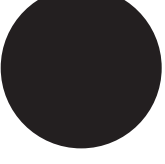
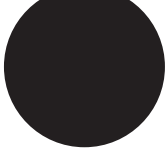
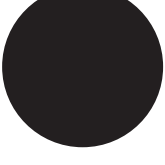
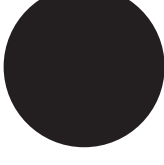
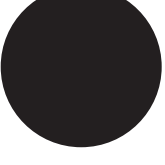
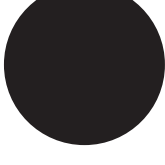
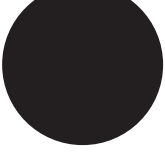
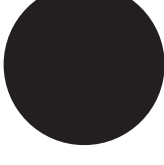
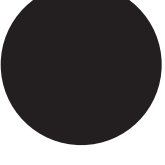
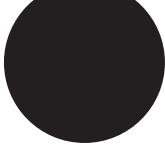
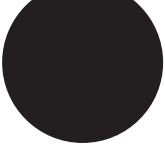
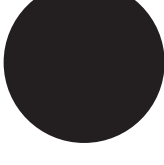
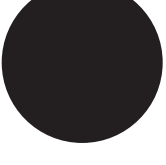
1					4
2					8
3					12
4					16
5					20
6					24
7					28
8					32
9					36
10					40

Four dice tally

4 to 14	15 to 24

Knotty problems

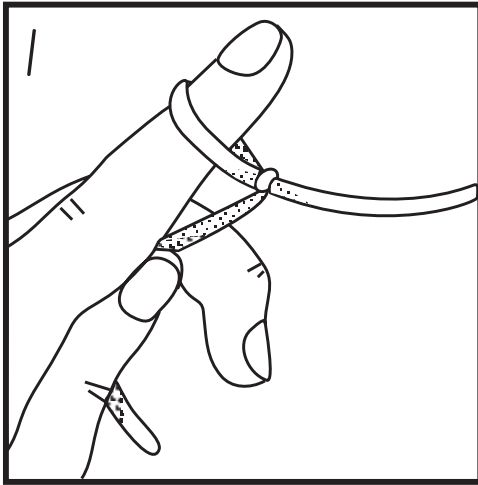

1
First, tie a loop of one end of your wool around your index finger and make a secure knot.

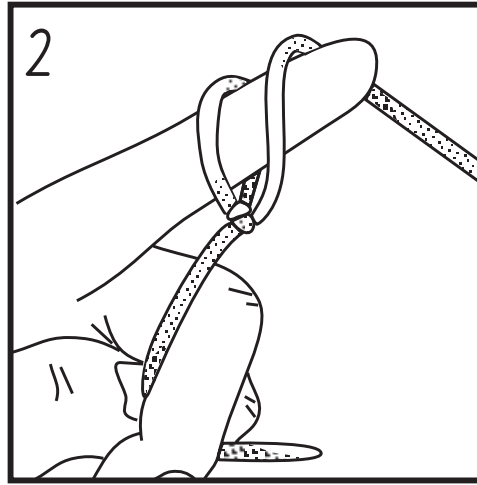

2
Then lift the longer part of your wool over your finger in front of this loop. Do not make a knot this time.

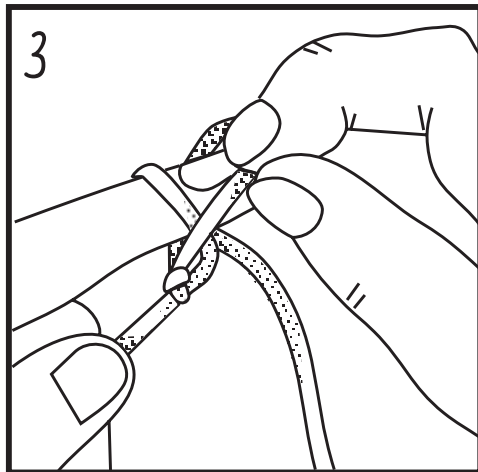

3
Lift the first, back loop up and forward over the front loop and drop it off your finger.

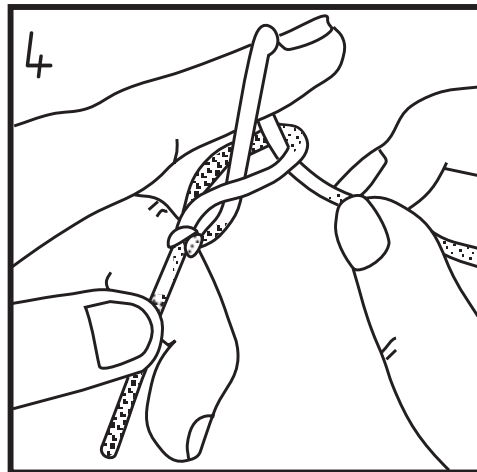

4
This makes your first knitted stitch. Pull your bottom short thread gently down to tighten the stitch.

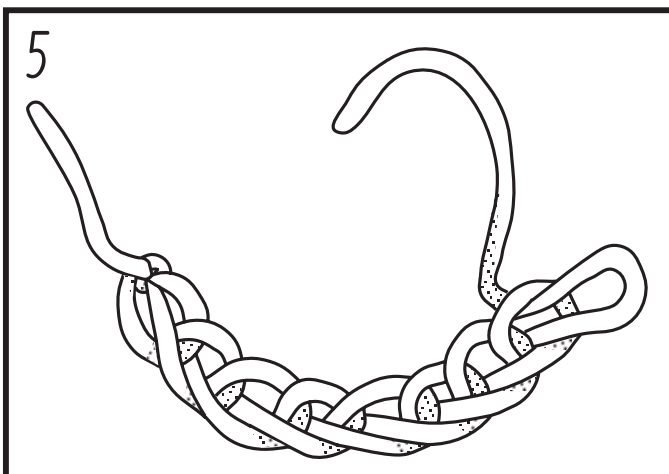

5
Lift more wool over in front of the loop you have left on your finger and lift the back loop over and off again. Repeat this until you have a long chain.

Using nets 1

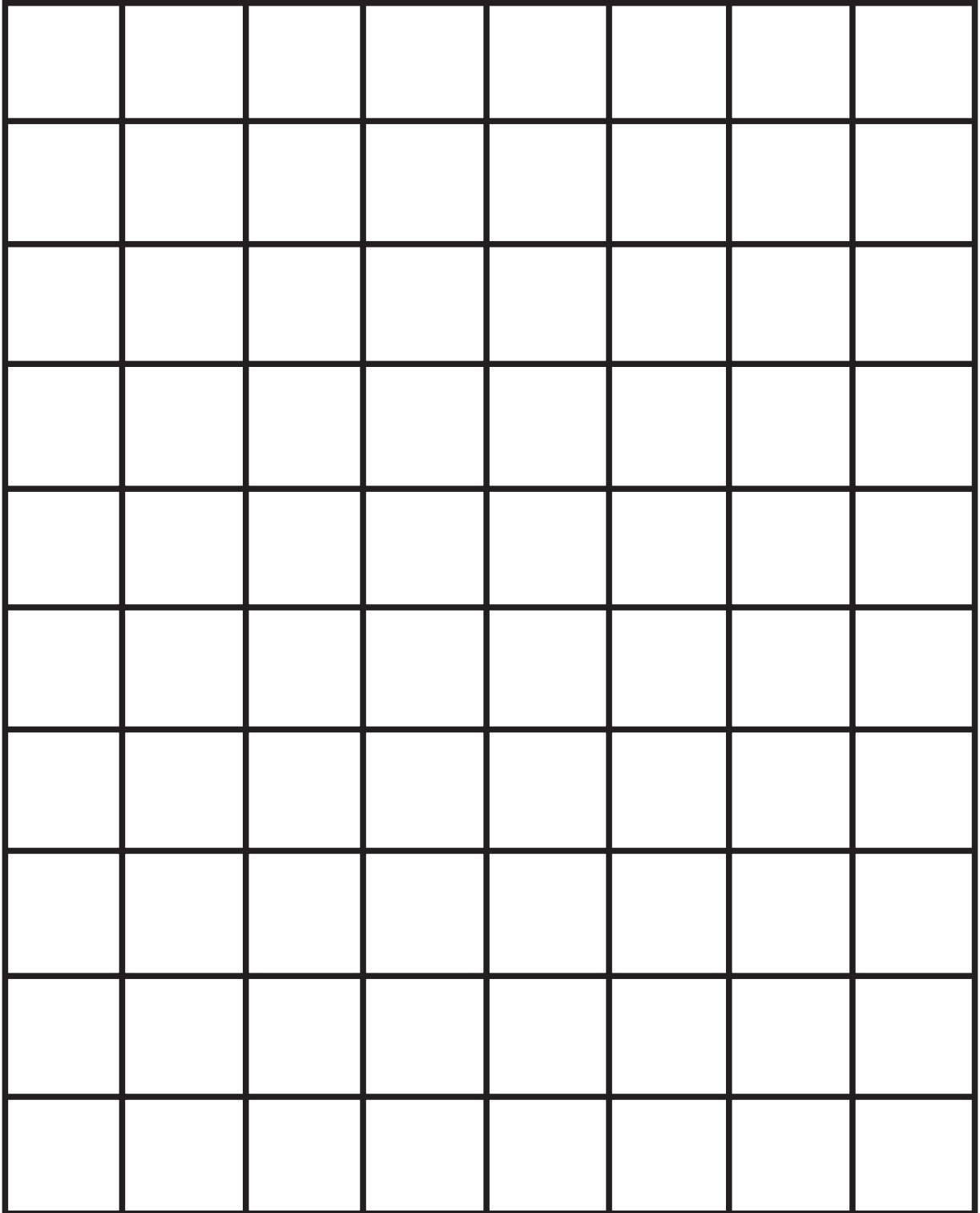

Create a triangle

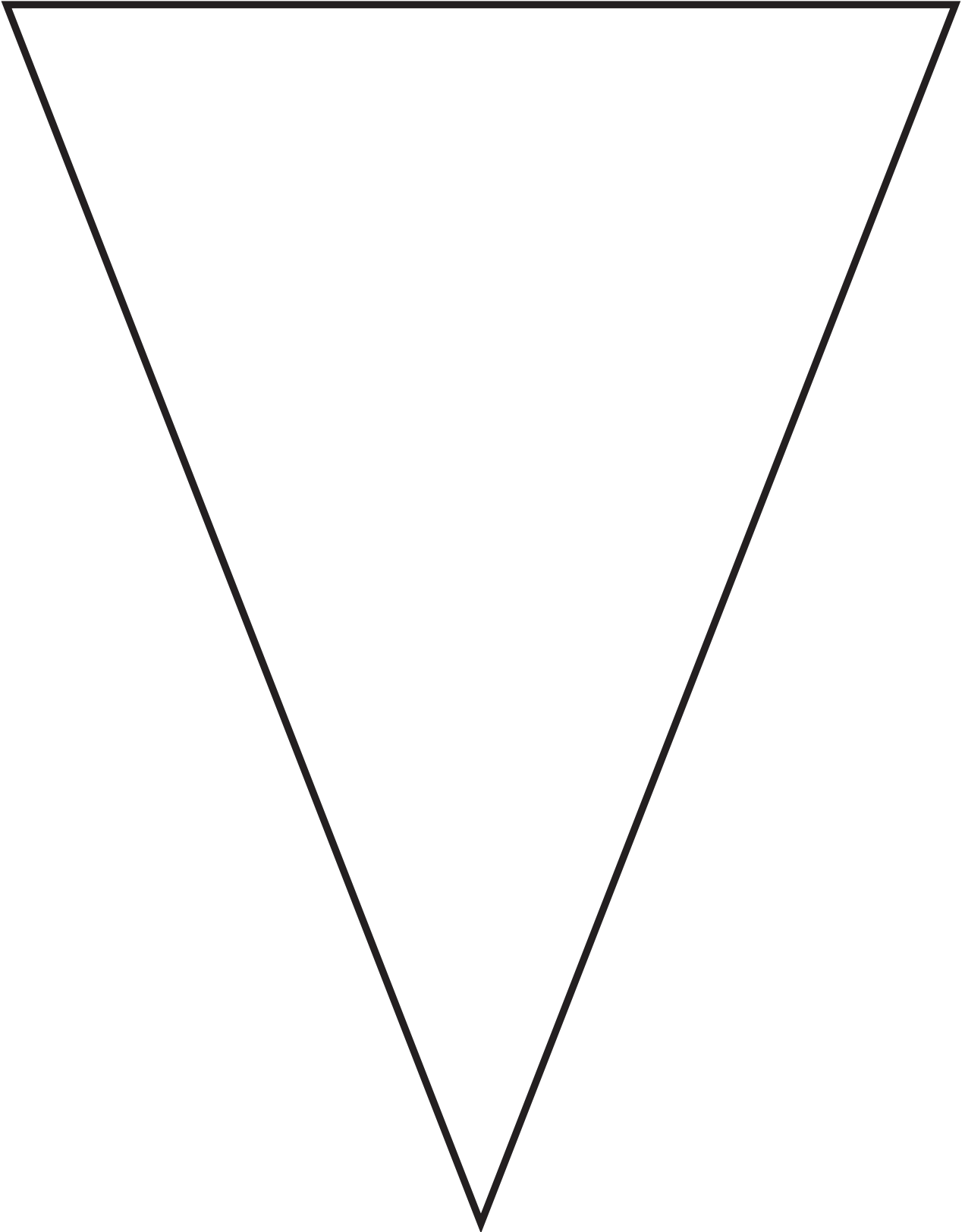

Recognising angles in shapes

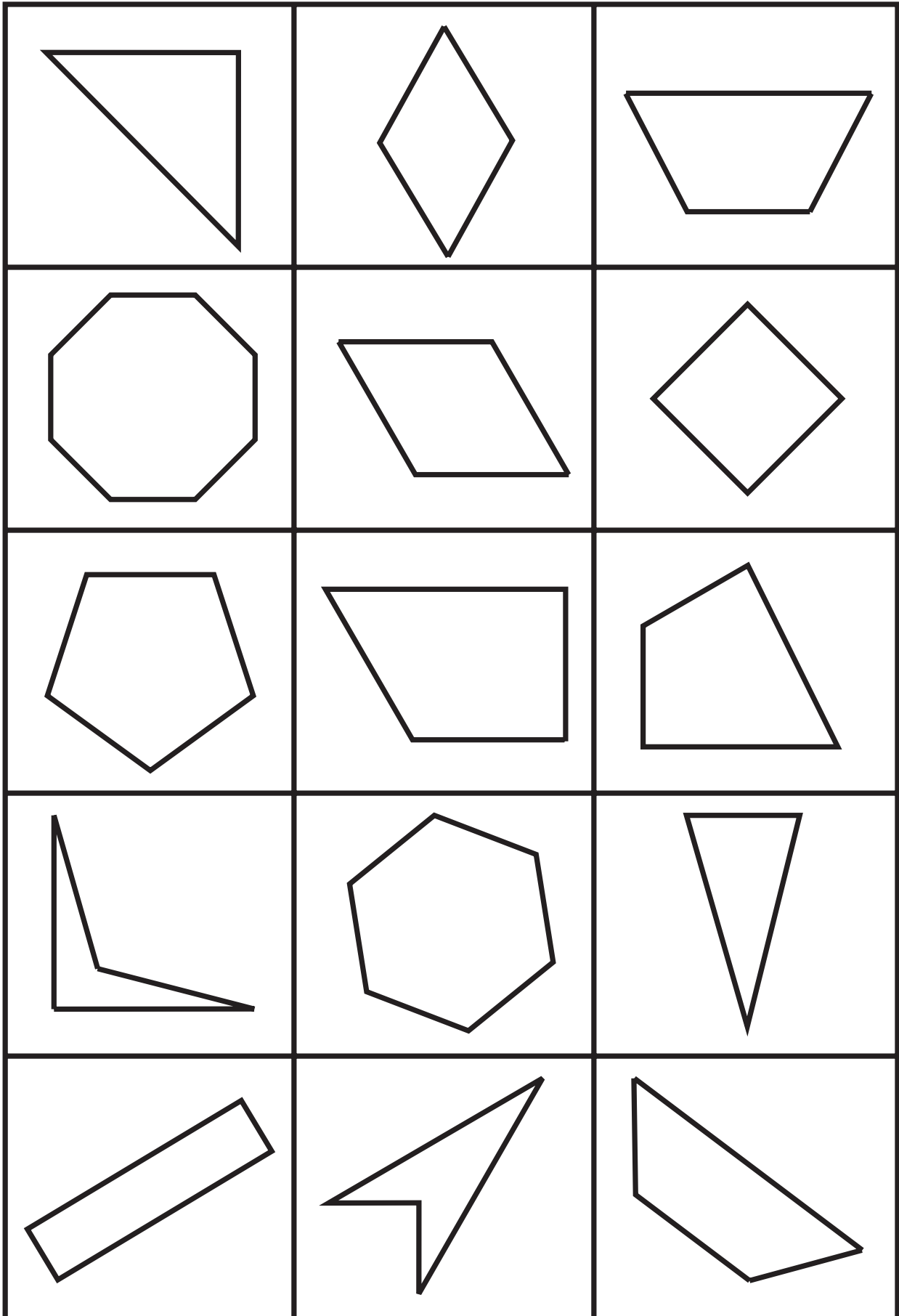

Recognising angles in shapes

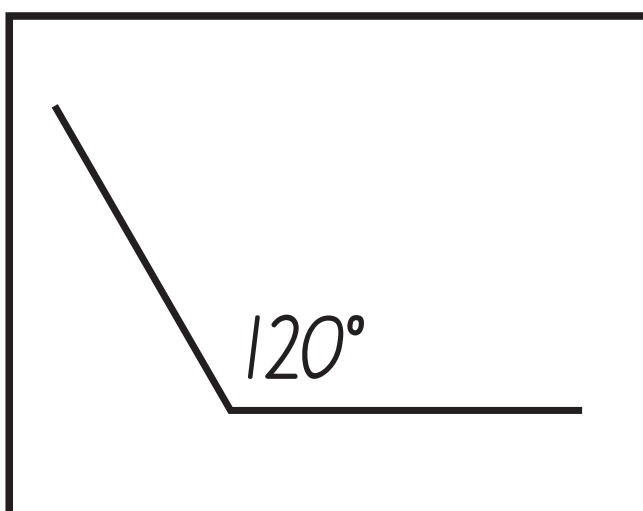
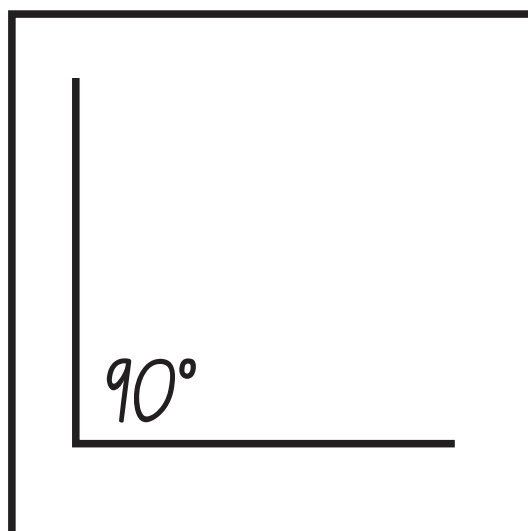
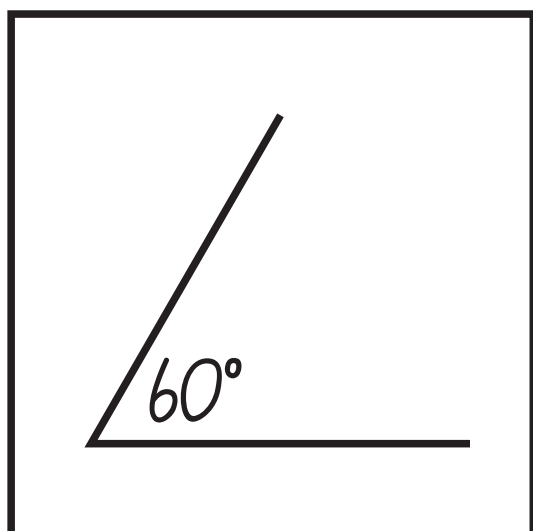
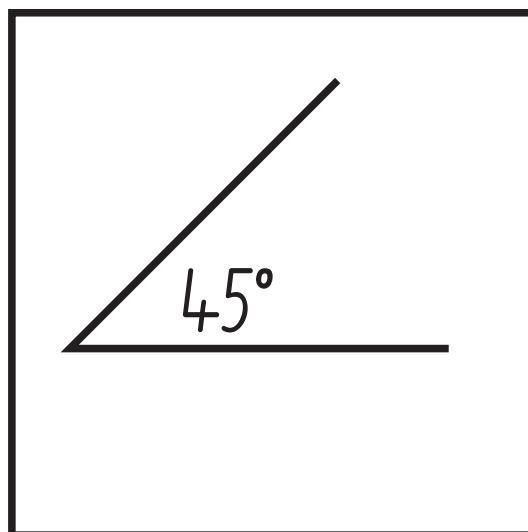
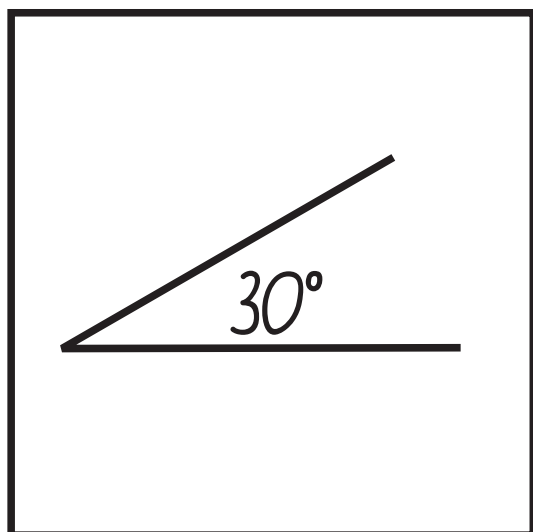

Assessment tasks

Task	Student response	Assessment
<p>T: <i>Here are nine counters.</i></p> <p>Briefly display counters and then screen.</p> <p>T: <i>Here are four counters.</i></p> <p>Briefly display counters and then screen.</p> <p>T: <i>How many counters are there altogether?</i></p>	<p>Able to correctly find the total without the use of material or fingers to represent the counters.</p>	<p>Note the strategy the student uses to solve the task. Do they use a non-count-by-one strategy?</p>
<p>T: <i>Can you tell me two different numbers that add up to 19?</i></p>	<p>Uses 10 and 9 as one combination or two non-standard combinations for 19.</p>	<p>Does the student need to calculate the answer for each combination or do they automatically recall the combinations?</p>
<p>T: <i>Start from 7 and count on by 10s. I'll tell you when to stop.</i></p>	<p>Counts by tens from 7 to 107.</p>	<p>Is the student able to count forwards and backwards off the decade?</p>
<p>Present a pile of counters (more than 18) to the student.</p> <p>T: <i>Using these counters, make three groups with six in each group. How many counters are there altogether?</i></p>	<p>Able to form equal groups.</p> <p>Determines the total.</p>	<p>Does the student count by ones or skip count to find the total?</p>

Task	Student response	Assessment
<p>Provide the student with a streamer 20cm long.</p> <p><i>T: Find three objects that are more than 100 cm.</i></p>	<p>Student uses the streamer to measure objects, marking the end of each measurement precisely to preserve size.</p>	<p>Does the student know that the lengths not the marks or spaces are counted?</p>
<p>Provide the students with a geoboard and rubber bands.</p> <p><i>T: Make three different triangles with one side of each triangle the same length.</i></p>	<p>Explains what is the same and what is different.</p>	<p>Does the student talk about angle size or lengths of sides?</p>

Maths bites

Using numeral cards 0 – 30

- Using the numeral cards 1–20, randomly select a card and show it to the students. Ask the students how many more to make 20?
- Use the numeral cards to solve verbal problems. For example, “I have 20 marbles. My sister has...(hold up a selected numeral card). How many altogether?”
- Distribute the numeral cards to the students. Ask the students to sequence themselves (without speaking) from highest to lowest.
- Place two sets of numeral cards face down on the floor. Ensure each set is on a different coloured card. Invite students to select two cards from one of the sets. The student with the highest total wins.
- Construct a set of numeral cards in the range 1–10. Invite a student to select five cards and display the cards to the class. Ask the students to use any of the selected numbers to make “12” by adding, subtracting, dividing or multiplying. Replace the cards used, shuffle the deck and repeat the activity.
- This activity could be used with two students playing or with two teams, each person in the team taking a turn. Place the numeral cards from 0–21 on the floor in sequence. The first player starts at “0” and adds on 1, 2 or 3 and states the total. The second player then adds on 1, 2 or 3 to the total and states the accumulated total. The players continue to take turns adding 1, 2 or 3 until one player reaches 21. This player or team is the winner. After playing for a few turns discuss with the students if there are any strategies you could use to try and win.
- Display the numeral cards 0–10. Ask the students to select the pairs that equal ten.

- Use numeral cards 0–10. Select a card from the pile and ask students to subtract the number from ten and state the answer. Alternatively, ask the students to add the number to ten. Vary the activity by asking students to subtract or add to 20.
- Place the numeral cards from 1–30 face down on the floor, in random order, in three rows of ten. Tell the students these are the numbers 1–30, but they are not in correct sequence. Ask a student to select a card and turn it face up. Have the student read the numeral and then place it where it should go in the correct sequence. The next student is handed the card that has been replaced and finds its correct location. Encourage the students to count up or down by tens and forwards and backwards by ones. Alternatively, ask the students to sequence the cards from highest to lowest.
- Hand out numeral cards in the range 1–30 to the students. Instruct the students to organise themselves (without speaking) into two rows, one of sequenced odd numbers and the other sequenced even numbers. The first row completed correctly is the winner.
- Hand out numeral cards for multiples of three. Instruct the students to organise themselves (without speaking) into the correct counting sequence. Repeat with other multiples.